



CARAVAN

& CAMPING AUS

Welcome to Caravan and Camping Aus!
Your Premium Supplier for the Caravan Industry.



2024
CATALOGUE



At Caravan and Camping Aus, we are dedicated to serving the caravan industry with top-tier products from the biggest brands, all under one roof.

Whether you're a manufacturer or an outdoor enthusiast, we provide everything you need to enhance your caravanning experience.

Discover the ultimate adventure with Caravan & Camping Aus.

Explore certified brands renowned for their quality and reliability, ensuring every journey is memorable.

With a comprehensive product range including durable accessories, RV parts, and essential camping supplies, we cater to every outdoor enthusiast needs.

Elevate your experience with our aftermarket options. Offering a wide variety of customisation possibilities from Air-conditioners, bathroom accessories, battery management systems, looms, vinyl flooring, electronics and all additional 12 volt solutions.

Personalise your caravan to suit your unique lifestyle.

Start your journey with us today and embrace the great outdoors like never before.



CARAVAN & CAMPING AUS

All Things Caravanning



FLOORING

Our European Sheet vinyl sets the bar above any other floor. Lighter and more flexible, this quality flooring saves you time and effort during installation and delivers outstanding durability from the outset. Whether it's our textile backing that smoothes out small irregularities in the surface and provides acoustic comfort. Or it's our compact backing that offers incredible wear and tear resistance and with low residual indentation.

With the Belgique and Eurlox Collection flooring ranges you will enjoy a wide choice of authentic natural looks combined with on-trend designs. The perfect match for any RV, caravan or modular unit, like tiny homes and container offices.

Belgique COLLECTION

EUROLUX



WEAR RESISTANT

Vinyl floors withstand heavy foot traffic and daily wear and tear, making it a durable long lasting flooring choice.



WATER RESISTANT

Seams are potential areas for water penetration which can be a concern in environments prone to spills or moisture. Seamless installation of vinyl floors minimise the opportunities for water to seep through joints.



HYPERGUARD+ PROTECTION & EASY CLEANING

The Polyurethane lacquer fights off stains, scuffs and marks. It ensures a long lasting look. Marks can be easily wiped or mopped away, maintaining a fresh appearance in mobile spaces



UNDERFOOT PROTECTION

Vinyl floors are softer underfoot, which makes it much easier to stand on for long periods of time, compared to any other hard-surface flooring option



SOUND ABSORPTION & THERMAL INSULATION

Vinyl floors provide excellent sound absorption of 19db. If you are looking for a warmth underfoot, vinyl floors have the ability to retain heat



SLIP RESISTANCE

Compact spaces, spills and mishaps can be hazardous. Fortunately Eurolux flooring combines a wide variety of looks with slip resistance properties for safer, stylish flooring.

TEXTILE BACKING

COMMERCIAL



EFFORTLESS FITTING

Less sub-floor preparation. Suitable for loose lay with double sided tape, staple gun systems and installation with appropriate adhesives.



INCREASED COMFORT

Textile backing for excellent acoustic absorption and insulation. Ideal walking comfort and better shock absorption.

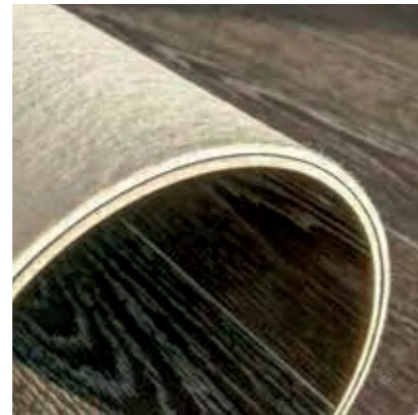

BELGIQUE RANGE

Durable wear layer of 0.55mm.

Class 23 intense residential use

Total Thickness: 3.20mm (with added layer of strength)

Residual Indentation: 0.20mm

UNPARALLELED RESISTANCE

During installation and usage

70 kN /m

Belgique
COLLECTION

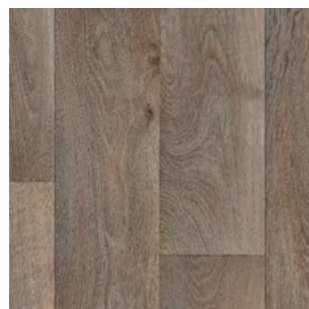

SAND OAK: CCA-BFC 1001

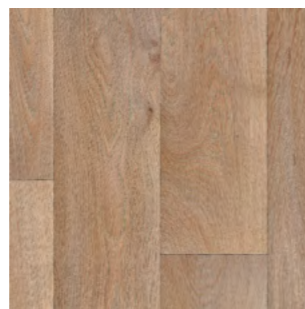

DELUXE OAK: CCA-BFC 1002

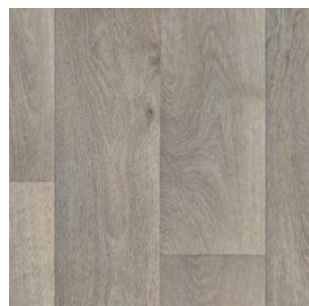

PLATINUM OAK: CCA-BFC 1003



LIGHT GREY SLATE: CCA-BFC 1004



CHARCOAL OAK: CCA-BFC 1005

Belgique
COLLECTION

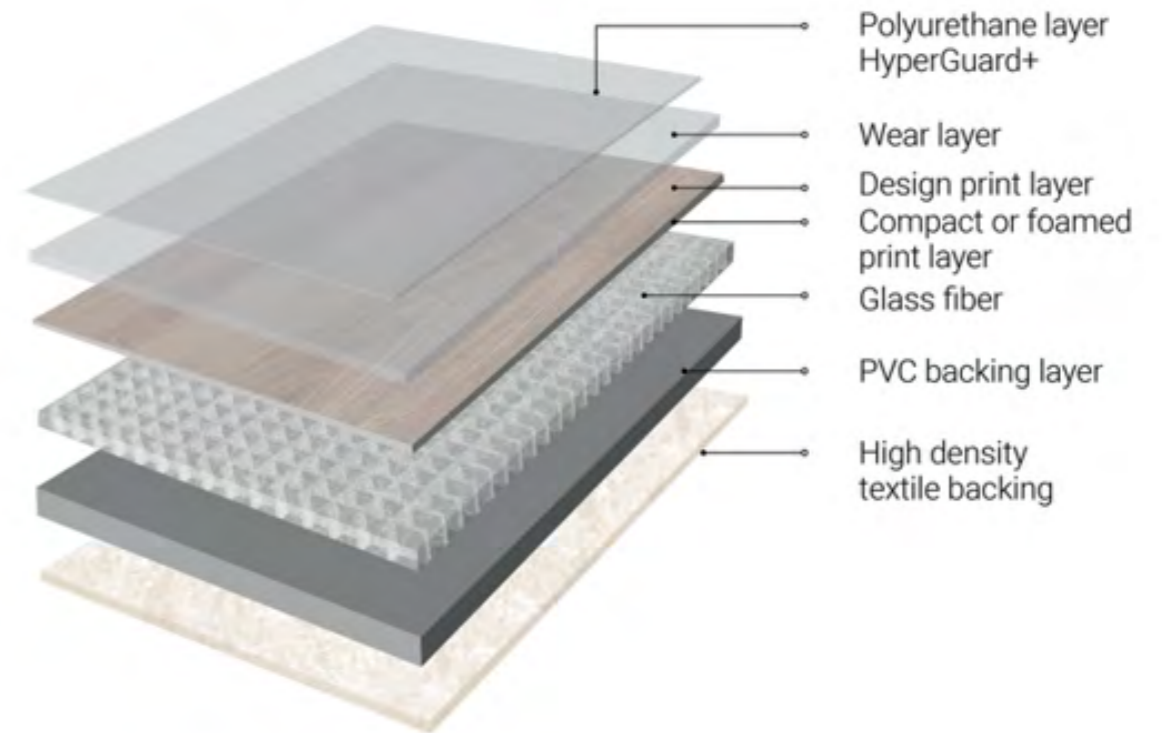

Five layers, each with their own specific function, combined into one strong unit. The result is a robust bind between all layers. Moreover, every Belgique floor has an Hyperguard+® PUR protective layer, safeguarding the floor from scratches and dirt. The glass fibre layer, finally, makes for ultimate dimensional stability: the floor will not show any signs of piercing or swelling, even under intensive use.

1. Polyurethane layer Hyperguard+
2. Wear layer
3. Design layer
4. PVC Backing layer
5. High Density Textile backing

COMPACT BACKING

COMMERCIAL PLUS



EFFORTLESS FITTING

Recommended installation with appropriate adhesives but also suitable for (semi -) loose lay



EXCELLENT DURABILITY

Average 34 kN/m: better than standard foamed residential sheet vinyl due to the compact backing foam.

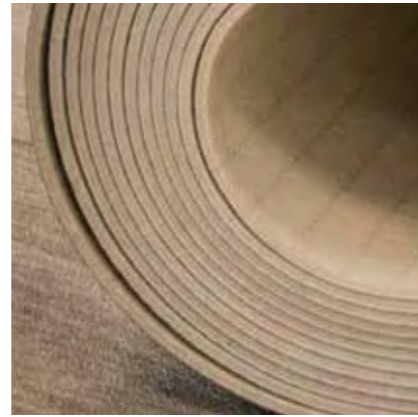

EUROLUX RANGE

Durable wear layer of 0.60mm.

Class 23 intense residential use

Total Thickness: 2.60mm (with added layer of strength)



ENHANCED RESIDUAL INDENTATION

0.12mm

EUROLUX



LAKEWOOD: CCA-BFC-2001



WILD OAK: CCA-BFC-2002

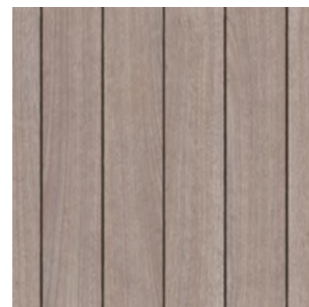

DRIFTWOOD: CCA-BFC-2003

EUROLUX

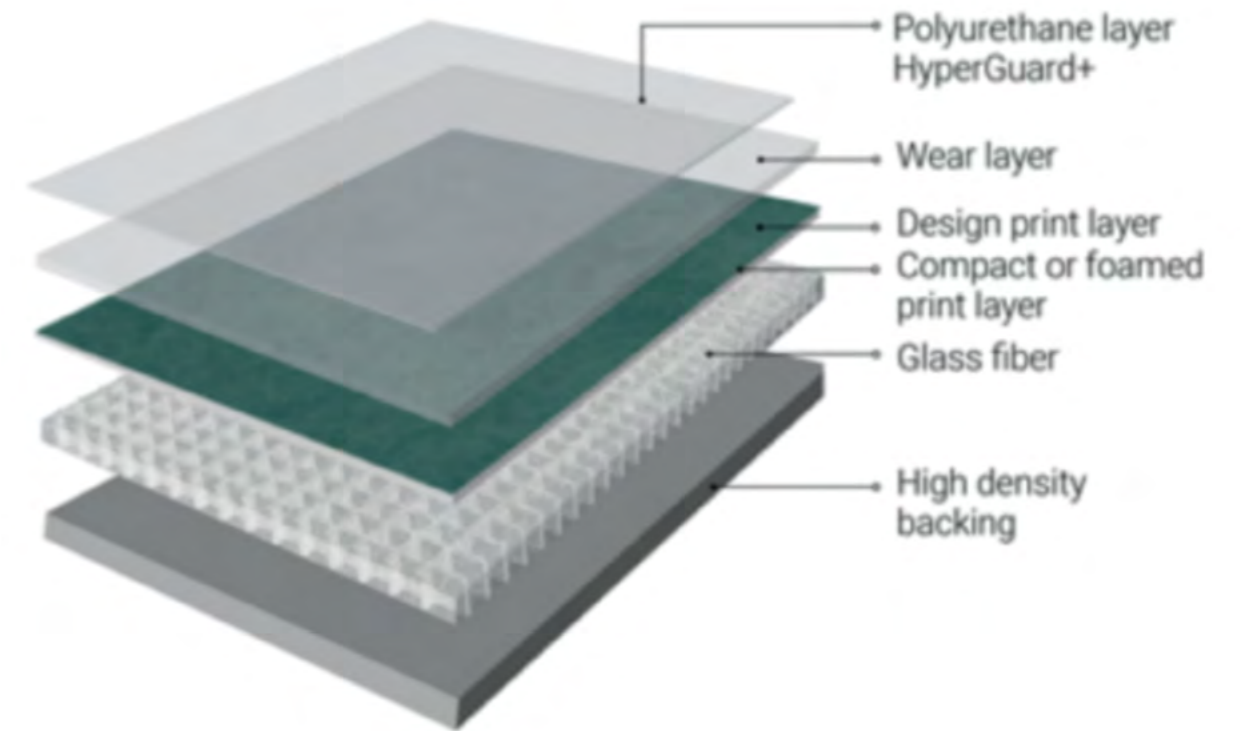

Five layers, each with their own specific function, combined into one strong unit. The result is a robust bind between all layers. Moreover, every EuroLux floor has an HyperGuard+® PUR protective layer, safeguarding the floor from scratches and dirt. The glass fibre layer, finally, makes for ultimate dimensional stability: the floor will not show any signs of piercing or swelling, even under intensive use.

1. Polyurethane layer Hyperguard+
2. Wear layer
3. Design layer
4. Glass fibre layer
5. Compact backing



A luxurious range for the discerning customer

Caravan Camping Australia's flooring collection has been designed for Australia's unique Caravan and RV industry, with colours that compliment and enhance any interior styling.

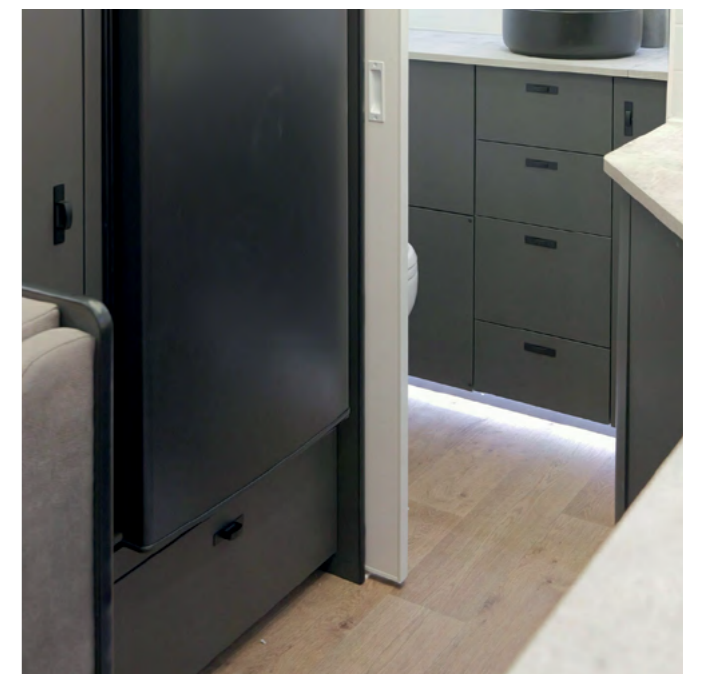

Technical Specifications

Flooring type /		Acoustic Textile Flooring
Heterogeneous PVC /	EN 650	
Type of installation /		Loose lay / glued
Level of use /	EN ISO 10874	23 - 33 - 42
Total thickness /	EN ISO 24346	3,20 mm
Wear layer /	EN ISO 24340	0,55 mm
Wear layer PUR treatment /		HyperGuard+
Total weight/m ² /	EN ISO 23997	ca. 2.124 g/m ²
Width /	EN ISO 24341	2,40 m
Standard Length /	EN ISO 24341	ca. 30 m
Weight of standard roll /		ca. 153 kg
Inflammability /	EN 13501	Cfl-s1
Slip resistance /	EN 13893	DS
Slip restraint /	EN 16165 Annex B	R11
Residual indentation /	EN ISO 24343-1*	norm ≤ 0,20 mm
Furniture leg resistance /	EN ISO 16581	PASS
Curling /	EN ISO 23999	≤ 8 mm
Electrical resistance /	EN ISO 1081	7,8 x 10 ⁸ Ohm
Static electrical propensity /	EN 1815	0,4 kV (antistatic)
Dimensional stability /	EN 23999	norm ≤ 0,40% ≤ 0,10%
Thermal conductivity /	EN 12667	0,070 W/(m.K)
Heat insulation /	EN 12667	0,0449 m ² .K/W
Binder quantity in wear layer /	EN 10582	Type I
Abrasion group /	EN 660-2	Class T
Indoor air quality /		LOW VOC
Acoustic insulation /	EN ISO 717-2	ΔLw 19 dB
Castor chair resistance /	EN ISO 4918	PASS
Castor type /	EN 12529	Type W
Light fastness /	ISO 105-B02	≥ 6
Underfloor heating /	EN 12524	Suitable ≤ 27°C
Resistance to chemicals /	EN ISO 26987	Very Good

* Semi-loose lay testing

The warranty covers manufacturing defects and premature wear in the event of normal use. Caravan and camping Australia reserves the right to change or amend any written information without notice. Ensure the latest information is being consulted by referring to the website. We reserve all rights for technical improvements.



Technical Specifications

Flooring type /		Compact Flooring
Heterogeneous PVC /	EN ISO 26986	
Type of installation /		Glued
Level of use /	EN ISO 10874	23 - 33
Total thickness /	EN ISO 24346	2,60 mm
Wear layer /	EN ISO 24340	0,60 mm
Wear layer PUR treatment /		HyperGuard+
Total weight/m ² /	EN ISO 23997	ca. 2.248 g
Width /	EN ISO 24341	2,40 m
Standard Length /	EN ISO 24341	ca. 30 m
Weight of standard roll /		ca. 162 kg
Inflammability /	EN 13501	TBC
Slip resistance /	EN 13893	DS
Slip restraint /	EN 16165 Annex B	TBC
Residual indentation /	EN ISO 24343-1	≤ 0,20 %
Furniture leg resistance /	EN ISO 16581	PASS
Curling /	EN ISO 23999	Norm < 8mm
Electrical resistance /	EN ISO 1081	
Static electrical propensity /	EN 1815	≤ 2 kv (antistatic)
Dimensional stability /	EN ISO 23999	≤ 0,40 %
Thermal conductivity /	EN 12667	TBC
Heat insulation /	EN 12667	TBC
Binder quantity in wear layer /	EN 11638	Type I
Abrasion group /	EN 660-2	Class T
Indoor air quality /		LOW VOC
Acoustic insulation /	EN ISO 717-2	18 dB
Castor chair resistance /	EN ISO 4918	PASS
Castor type /	EN 12529	Type W
Light fastness /	ISO 105-B02	≥ 6
Underfloor heating /	EN 12524	Suitable
Resistance to chemicals /	EN ISO 26987	Very good

The warranty covers manufacturing defects and premature wear in the event of normal use. Caravan and camping Australia reserves the right to change or amend any written information without notice. Ensure the latest information is being consulted by referring to the website. We reserve all rights for technical improvements.



LED Light Bars

Iluma 3.8" Light Bar

ILU-6028-18



Iluma Light Bar Double Row 3W Cree 6 LED 3.8" 96mm Length Flood Beam Black

Iluma 4.5" Light Bar

ILU-6019-9



Iluma Light Bar 3W Cree 3 LED 4.5" 111mm Length Flood Beam Black

Iluma 7.5" Light Bar

ILU-6019-18



Iluma Light Bar 3W Cree 6 LED 7.5" 192mm Length Flood Beam Black

Iluma 11" Light Bar

ILU-6019-27



Iluma Light Bar 3W Cree 9 LED 11" 273mm Length Flood Beam Black

Iluma 11.8" Light Bar

ILU-6028-72



Iluma Light Bar Double Row 3W Cree 24 LED 11.8" 300mm Length Flood Beam Black

Iluma 14" Light Bar

ILU-6019-36



Iluma Light Bar 3W Cree 12 LED 14" 354mm Length Flood Beam Black

LED Light Bars

Iluma 17" Light Bar

ILU-6019-45



Iluma Light Bar 3W Cree 15 LED 17" 435mm Length Flood Beam Black

Iluma 20" Light Bar

ILU-6019-54



Iluma Light Bar 3W Cree 18 LED 20" 516mm Length Flood Beam Black

Iluma 46.2" Light Bar

ILU-6019-117



Iluma Light Bar 3W Cree 39 LED 42.6" 1083mm Length Combo Beam Black

Contact Us For More Info!

☎ (03) 9305 1555

✉ info@caravanandcampingaus.com

📍 www.caravanandcampingaus.com

🏠 1831 Sydney Rd, Campbellfield, VIC 3061

Awning Lights

Reading Lights

Awning Light **AWN01** Awning Light Satin **AWN02**



Black UV Coating
ASW01-B2
White ASW01-W



Silver Awn02-S
Black Awn02-B

Slim Awning Light **ILU-23260BLK**



Black 260MM x 23MM x 24MM
ILU-23260BLK

Amber/White Awning Light **ILU-CILE23450AWB**



Black 443MM
ILU-CILE23450AWB

Slim Awning Light Water Rated **ILU-KW2275B-02**



Black 506x35 x 28mm
12-28V 1000 LUMEN IP67
ILU-KW2275B-02

Slim Awning Light **ILU-23260BLK** Insect Repellent Light **ILU-13712CA-B**



Black
260MM x 23MM x 24MM
ILU-23260BLK



Black 200MM
ILU-13712CA-B

1000 Lumen Output Awning Light **ILU-KW289B-01**



Black
230x54x46mm
12-28V Ip67
ILU-KW289B-01



Amber/White
Awning Light Blk
230x54x46mm,
Ip67 White 750 Lm /
Amber 250In Output
ILU-KW289B-01WA



BLACK 10-30V
PUSH BUTTON
LU-S001-BL



CHROME 10-30V
PUSH BUTTON
ILU-S001-CH



NICKEL 10-30V
PUSH BUTTON
ILU-S001-NL



BLACK 10-30V
PUSH BUTTON
ILU-SS031-BL



CHROME 10-30V
PUSH BUTTON
ILU-SS031-CH



NICKEL 10-30V
PUSH BUTTON
ILU-SS031-NL



BLACK 10-30V
PUSH BUTTON
ILU-SS050-BL



CHROME 10-30V
PUSH BUTTON
ILU-SS050-CH



NICKEL 10-30V
PUSH BUTTON
ILU-SS050-NL



FLEXIBLE
FLOOD
STANDARD
ROCKER SWITCH
ILU-FRL-01S



FLEXIBLE
FLOOD LIGHT
TOUCH SWITCH
ILU-FRL-01T



STEEL BED
LAMP
ILU-CIL112185C



BLACK LAMP
W/ USB
ILU-12185BUSB



READING LAMP
- SWITCH
RL-01S-12V



DUAL COLOUR
W/ USB - BLUE/
WHITE
ILU-12175CUSB



READING LAMP
- TOUCH
RL-01-TF



READING LAMP
BLACK ILU-Y14002-BLK
CHROME ILU-Y14002-CHROME

Dome & Down Lights

LED Downlight IDL60S-F Awning Light Satin IDL60ST-F



**LED DOWNLIGHT
- 9-16V**
IDL60S-F



**LED DOWNLIGHT
- TOUCH SWITCH**
IDL60ST-F

Square Downlight ISQ55B-II Caravan Slim Downlight ILU-C0416001

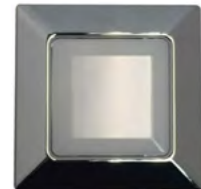

**SQUARE
DOWNLIGHT**
ISQ55B-II



**CARAVAN SLIM
DOWNLIGHT**
ILU-C0416001

Dome Light Frost IDL140-T2 Dome Light White IDL140-F-WHT



**DOME LIGHT
TOUCH SWITCH -
FROST**
IDL140-T2



**DOME LIGHT
- WHITE**
IDL140-F-WHT

Dome Light Frost IDL140S-F-CHR Dome Light Chrome IDL140-F-CHR



**LED DOME LIGHT
SWITCH**
IDL140S-F-CHR



**DOME LIGHT
- CHROME**
IDL140-F-CHR

Dome Light White IDL180-F-WHT DOME Dome Chrome Switch IDL180S-F



**DOME LIGHT
- WHITE**
IDL180-F-WHT DOME



**DOME CHROME
SWITCH**
IDL180S-F

Dome Light Chrome IDL180-F



**DOME LIGHT
- CHROME**
IDL180-F

Chassis Components

Brake Loom ILU-4MMTSSABLOOM Brake Loom ILU-4MMTSDABLOOM



**TWIN SHEATH
SINGLE AXLE**
ILU-4MMTSSABLOOM



**TWIN SHEATH
DUAL AXLE**
ILU-4MMTSDABLOOM

Fans

Sirocco II Fan



BLACK
ILU-S7010CAB



WHITE
ILU-S7010CAW

For full range visit
www.caframobrand.com

Contact Us For More Info!

(03) 9305 1555

info@caravanandcampingaus.com

www.caravanandcampingaus.com

1831 Sydney Rd, Campbellfield, VIC 3061

Mechanisms

Mechanisms



35A DOUBLE POLE MECH
WHITE ILU-DPM35A
HWS ILU-DPM35AHWS
STOVE ILU-DPM35ASTOVE



16A SWITCH MECH
WHITE ILU-SM16A
BLACK ILU-SM16AB
PUMP ILU-SM16APUMP



10A SWITCH MECH
WHITE ILU-AS001
BLACK ILU-AS001B
SILVER ILU-AS001S



10A SWITCH MECH - WHITE WITH PRINT
AWNING ILU-AS001-AWNING
FRIDGE ILU-AS001FRIDGE
PUMP ILU-AS001PUMP
LED BAR ILU-AS001BLK-LEDBAR



10A SWITCH MECH - BLACK WITH PRINT
FRIDGE ILU-AS001FRIDGE
PUMP ILU-AS001PUMP



12V DIMMER SWITCH - DIMMER POD
 ILU-CIDMP3209



2A USB MECHANISM
WHITE ILU-AS-USB
BLACK ILU-AS-USB-B
SILVER ILU-AS-USB-S



HDMI MECH
 ILU-HDMI



BLANK WHITE BUTTON
 ILU-CIBB



INTERMEDIATE MECH 10A
 ILU-IM/10A



ROTARY SWITCH 15A
 ILU-CLI30RSM2WE



SWITCH MECH 3 POSITION
 ILU-CLI39MPLAINWE



10A SWITCH MECH BLACK W/ ISO PRINT
 ILU-AS001B-ISO



10A DOUBLE POLE BLACK SWITCH W/ WHITE A/C PRINT
 ILU-AS003AC-BLK



10A DOUBLE POLE WHITE SWITCH W/ BLACK A/C PRINT
 ILU-AS003AC



10A DOUBLE POLE FRIDGE MECH - WHITE
 ILU-AS003FRIDGE



10A DOUBLE POLE WHITE SWITCH W/ BLACK STOVE PRINT



10A DOUBLE POLE BLACK SWITCH W/ WHITE STOVE PRINT
 ILU-AS003STOVE-BLK



F TO PAL CONNECTOR MECH
 ILU-TVCM



F TO F CONNECTOR MECH
 ILU-TVFM



RJ45 MECH
 ILU-RJ45M

Switches

Switches

Gang Frame - White



Gang Frame - Silver Plate



Gang Cover Plate - Brush Metal



Gang Architrave Switch - White



Gang Architrave Switch - Black



Gang Switch - White

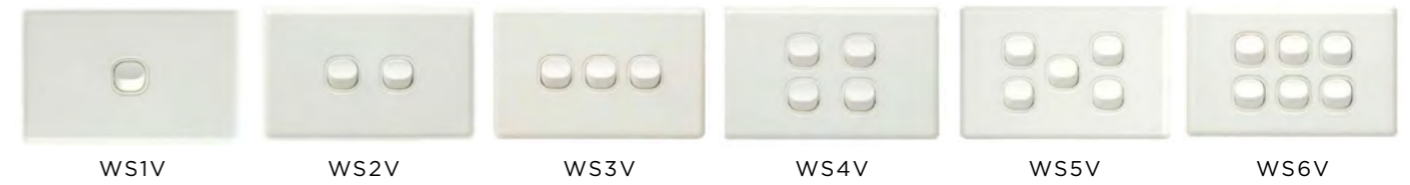

Gang Switch - Black



Gang Switch Gloss - Silver & White



Gang Switch Gloss - Silver & Black



Switches

Switches

Gang Frame Without Switch - White



Gang Frame Without Switch - Black



Gang Frame Without Switch - Silver

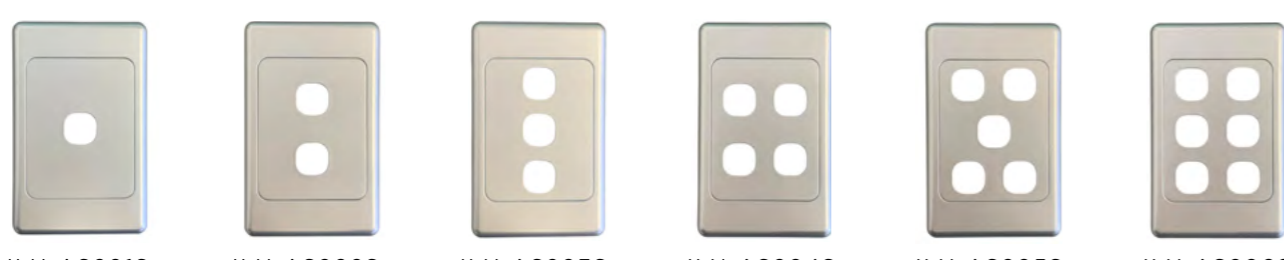

Blank Plates

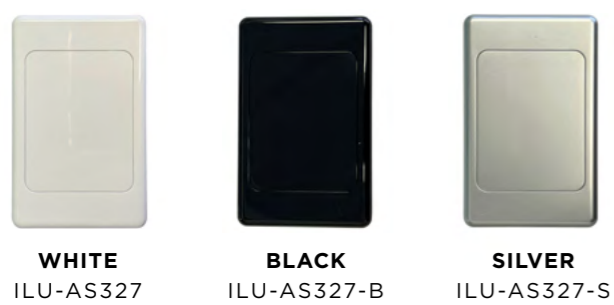

Gang Switch Vertical - White



Gang Switch Vertical - Black



Gang Switch Vertical - Silver



Gang Architrave Switch



Switches

Automotive Cable

Double Powerpoint 2 Pole



WHITE
WGPO2/2W



BLACK
WGPO2/2B

Double Powerpoint 2 Pole D-Series

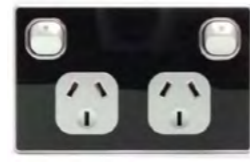

SILVER/BLACK
WGPO2/2D/SB



SILVER/WHITE
WGPO2/2D/SW

Double Powerpoint Cover Plate



SILVER
WGPO2/SP



BRUSH METAL
WGPO2/BSMC

Single Powerpoint 2 Pole



WHITE
ILU-CIP1D



15A WHITE
ILU-CIP1D15

Double Powerpoint 2 Pole



15A WHITE
ILU-CIP2D15



**250V 10A
W/ DOUBLE USB WHITE**
ILU-WGPO2/USB WHT



**250V 10A
W/ DOUBLE USB BLACK**
ILU-WGPO2/USB BLK

Plug Base - 70mm



ILU-PB1N

10a 2pole Single Powerpoint Vertical



WHITE
ILU-AS314-



BLACK
ILU-AS314-V-B



SILVER
ILU-AS314-V-S

10a 2pole Double Powerpoint Vertical



WHITE
ILU-AS316-V



BLACK
ILU-AS316-V-B



SILVER
ILU-AS316-V-S

Powerpoint Single 2 Pole 10a



WHITE
ILU-AS317



BLACK
ILU-AS317-B



SILVER
ILU-AS317-S

Powerpoint Double 2 Pole 10a



WHITE
ILU-AS318



BLACK
ILU-AS318-B



SILVER
ILU-AS318-S



OBS CABLE - 30M
BLACK ILU-00BSBL30
RED ILU-00BSRD30

00BS CABLE - 30M
BLACK ILU-00BSBL30
RED ILU-00BSRD30

000 B&S CABLE - 30M
BLACK ILU-000BSBK30
RED ILU-000BSRD30

6 B&S CABLE - 30M
BLACK ILU-6BSBK30
RED ILU-6BSRD30

6BS CABLE - 100M
BLACK ILU-6BSBK100
RED ILU-6BSRD100

**2 B&S V90 BATTERY
CABLE - 30M**
BLACK ILU-2BSBK30
RED ILU-2BSRD30

**4 B&S V90 BATTERY
CABLE - 30M**
BLACK ILU-4BSBK30
RED ILU-4BSRD30



**CAT 5 CABLE
- 30M**
ILU-CAT530M



**CAT 6 CABLE
- 305M**
ILU-CAT6



**TELEPHONE
CABLE - 10M**
ILU-TELECAB



**TELEPHONE CABLE
3 PAIR FLAT**
100M ILU-TELCAB100MF
305M ILU-TELCAB305M



**RG6 COAXIAL
CABLE - 305M**
ILU-RG6COAX305M



**CABLE KING RG59
QUAD CABLE 305M**
ILU-CIDRG59C305M



**7 CORE X 3MM V90 TRAILER
CABLE 100M**
ILU-CIC7C3MMBK100



**2.5MM 2 CORE &
EARTH PURPLE 100M**
ILU-CICTPSPVC25



**1.5MM GREY FLEX
3 CORE**
ILU-CIC15FLEX



**2.5MM GREY FLEX
3 CORE 100M**
ILU-CIC25FLEXSY100



TWIN & EARTH CABLE
1.5MM ILU-1.5MMTE
2.5MM ILU-2.5MMTE
4MM ILU-4mmTE



6MM 240V CABLE
ILU-6.0MM240V

Automotive Cable

Automotive Cable



**YELLOW/GREEN
EARTH CABLE - 100M**
2.5MM ILU-2.5MMG/YEARTH100M
4MM ILU-4MMG/YEARTH100M



**2.5MM GREY/BLACK
SPEAKER CABLE ROLL**
100M ILU-2.5MSPKCBL/GREY100M
500M ILU-2.5MSPKCBL/GREY500M



3MM CABLE - 100M
BROWN ILU-3MMBROWN100M
PURPLE ILU-3MMPURPLE100M
ORANGE

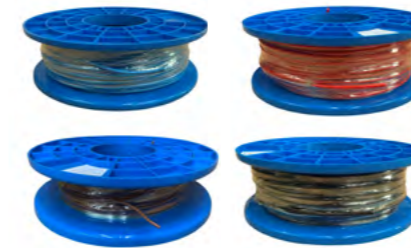

4MM F8 CABLE 100M
BLUE/WHITE ILU-4MMFIG8BLUE/WH100M
BROWN/WHITE ILU-4MMFIG8BROWN/WH100M
GREEN/BLACK ILU-4MMFIG8GREEN/BLK100M
RED/BLACK ILU-4MMFIG8RED/BLK100M



4MM F8 CABLE 500M
BLUE/WHITE ILU-4MMFIG8BLUE/WH500M
BROWN/WHITE ILU-4MMFIG8BROWN/WH500M
RED/BLACK ILU-4MMFIG8RED/BLK500M



3MM CABLE - 500M
BLACK ILU-3MMBLACK500M
BLUE ILU-3MMBLUE500M
GREEN ILU-3MMGREEN500M
ORANGE ILU-3MMORANGE500M
PINK ILU-3MMPINK500M
PURPLE ILU-3MMPURPLE500M
RED ILU-3MMRED500M
WHITE ILU-3MMWHITE500M
YELLOW ILU-3MMYELLOW500M
BROWN ILU-3MMBROWN500M

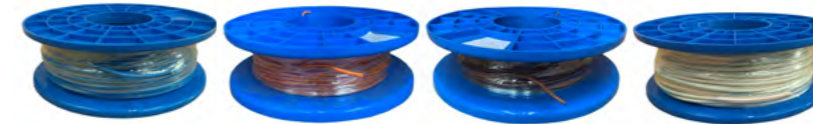

5MM CABLE 100M ROLL
BLUE ILU-5MMBLUE100M
ORANGE ILU-5MMORANGE100M
PURPLE ILU-5MMPURPLE100M
WHITE ILU-5MMWHITE100M



6MM CABLE 100M ROLL
BLACK ILU-6MMBLACK100M
BLUE ILU-6MMBLUE100M
PINK ILU-6MMPINK100M
RED ILU-6MMRED100M
WHITE ILU-6MMWHITE100M
YELLOW ILU-6MMYELLOW100M



3MM FIGURE 8 100M ROLL
BLUE/WHITE ILU-3MMFIG8BLUE/W100M
BROWN/WHITE ILU-3MMFIG8BROWN/W100M
RED/BLACK ILU-3MMFIG8RED/BLK100M



3MM FIGURE 8 CABLE - 500M
BLACK/WHITE ILU-3MMFIG8BLK/WHITE500M
BLUE/WHITE ILU-3MMFIG8BLUE/WHITE500M
RED/BLACK



4MM CABLE 100M
BLACK ILU-CIC4MMBK100
WHITE ILU-CIC4MMWH100
RED ILU-CIC4MMRD100
ORANGE ILU-CIC4MMOR100
PINK ILU-CIC4MMPK100
BLUE ILU-CIC4MMLB100
PURPLE ILU-CIC4MMVL100



8MM CABLE 100M ROLL
BLACK ILU-8MMBLACK100M
RED ILU-8MMRED100M



10MM CABLE 100M ROLL
BLACK ILU-10MMBLACK100
RED ILU-10MMRED100



**TWIN SHEATH DOUBLE
INSULATED - 100M**
4MM ILU-4MMTWIN SHEATH
5MM ILU-5MMTWIN SHEATH
6MM ILU-6MMTWIN SHEATH100M



4MM CABLE 100M ROLL
RED ILU-4MMRED100M
ORANGE ILU-4MMORANGE100M



4MM CABLE 500M ROLL
BLACK ILU-4MMBLACK500M
RED ILU-4MMRED500M



**CABLE SOLAR TWIN PV1-F
4.0MM TUV - 100M**
ILU-SPSF84TUV



**4MM 3 CORE FLEX
- BLACK**
ILU-4MM3COREFLEX



TWIN SHEATH CABLE - 100M
6 B&S ILU-6BSTWIN
8 B&S ILU-CIC8BSTWIN

Radio With CD/DVD/Bluetooth

ILU-CD/DVD/BTCOMBO



Iluma Radio Headunit Stereo With CD/DVD/Bluetooth Combo

Clarion FZ307AU Short-Body Head-Unit

ILU-FZ307AU



Clarion FZ307AU Radio Head Unit Short-Body Bluetooth MP3 WMA USB SD iPod iPhone

Finch 6.5" Low Profile 60w Slimline Speakers

FIN-DBS6024B



Finch 6.5" Low Profile 60w Slimline Speakers Black 1 pair

Finch 6.5" Low Profile 60w Slimline Speakers

FIN-DBS6024W



Finch 6.5" Low Profile 60w Slimline Speakers White 1 pair

Finch 6.5" LED 60w Slimline Speakers

FIN-DBS6024B-LED



Finch 6.5" Low Profile 60w LED Slimline Speakers Black 1 pair

Finch 6.5" LED 60w Slimline Speakers

FIN-DBS6024W



Finch 6.5" Low Profile 60w LED Slimline Speakers White 1 pair

Clarion 6.5" 2-Way Ultra-Slim 6.5" Speaker

ILU-CME1624RB



Clarion 6.5" 2-Way Ultra-Slim 50w Water Resistant Speaker Single Black

Clarion 6.5" 2-Way Ultra-Slim 6.5" Speaker

ILU-CME1624RW



Clarion 6.5" 2-Way Ultra-Slim 50w Water Resistant Speaker Single White

Iluma 6.5" Low Profile 50w Speaker

ILU-MRS-65B



Iluma 6.5" Low Profile 50w Slimline Water Resistant Speaker Single Black

Iluma 6.5" Low Profile 50w Speaker

ILU-MRS-65W



Iluma 6.5" Low Profile 50w Slimline Water Resistant Speaker Single White

Finch 24 Inch 12V Smart TV

FIN-LED-24SMART



Finch 24 Inch 60cm LED 12V Smart TV High Definition

Iluma 24 Inch 12V Smart TV & DVD

ILU-SMARTTV24-DVD



Iluma 24 Inch 60cm LED 12V Smart TV and DVD Combo High Definition

Iluma 32 Inch 12V Smart TV & DVD **ILU-SMARTTV32-DVD**



Iluma 32 Inch 81cm LED 12V Smart TV and DVD Combo High Definition

Finch Double TV Bracket Arm **FIN-BA2730**



Finch Double TV Bracket Arm with Locking Pin

Finch Triple TV Bracket Arm **FIN-BA2750**



Finch Triple TV Bracket Arm + Locking Pin

Iluma Double TV Bracket Arm **ILU-LO26-2**



Iluma Double TV Bracket Arm with Locking Pin

Offroad Caravans

Autolift System For Caravan With 2x Under And 2x Side Mounts Brackets	TIK-C-2U2S-L
AutoLift System for Caravan with 4x Side Chassis Mounting Brackets	TIK-C-SCM-L
AutoLift System for Caravan with 4x Under Chassis Mount Brackets	TIK-C-UCM-L

Low Caravans

AutoLift System for Caravan with 2x Under and 2x Side Mounts brackets	TIK-C-2U2S
AutoLift System for Caravan with 4x Side Chassis Mounting Brackets	TIK-C-SCM
AutoLift System for Caravan with 4x Under Chassis Mount Brackets	TIK-C-UCM



New Stock

MOBILE AIRCONDITIONER HB2400DUB



Power supply	1PH/230-240V /50Hz
Cooling capacity	2400W
Power input cooling	980W
Current cooling	4.3A
Heating capacity	2000W
Power input heating	920W
Current heating	4.1A
Maximum input power	1120W
Maximum current	4.9A
Weight (kg)	30kg
Dimension (mm)	690L x 442W x 287H

Suits smaller caravans and motorhomes. Lightweight roof top unit and plenum combined to reduce the total weight. Excellent performance and good looks make it the best choice for light pop top caravans.

INVERTER AIR CONDITIONER HB2800V-GB



Power supply	1PH/230~240V/50HZ
Cooling capacity	2800W
Power input cooling	1100W
Current cooling	4.8 A
Heating capacity	2600W
Power input heating	1100W
Current heating	4.8 A
Maximum input power	1300W
Maximum current	5.8 A
Weight (kg)	31.5kg
Dimension (mm)	855L x 657W x 215H

If the HB2800V is for you but you are looking for a sleeker look, welcome HB2800V-GB in the grey/black combo.

MOBILE AIR CONDITIONER HB2800



Power supply	1PH/230~240V/50Hz
Cooling capacity	2800W
Power input cooling	1150W
Current cooling	5.0A
Heating capacity	2600W
Power input heating	1120W
Current heating	4.8A
Maximum input power	1430W
Maximum current	6.3A
Weight (kg)	32.5kg
Dimension (mm)	855L x 657W x 215H

With outstanding performance and only 85 cm in length, the Houghton Belaire HB2800 provides greater flexibility for hatches, solar panels, satellite dishes and other equipment without sacrificing year-round comfort.

MOBILE AIR CONDITIONER HB3500



Power supply	1PH/230~240V/50Hz
Cooling capacity	3500W
Power input cooling	1300W
Current cooling	5.6A
Heating capacity	3500W
Power input heating	1200W
Current heating	5.2A
Maximum input power	1500W
Maximum current	6.5A
Weight (kg)	35.5 kg
Dimension (mm)	998L x 680W x 340H

Powerful performance for larger motorhomes and caravans. Features a low plenum that suits free discharge or ducted air distribution systems. Colors can be customized to better complement exterior paintwork.

INVERTER AIRCONDITIONER HB2800V



Power supply	1PH/230~240V/50HZ
Cooling capacity	2800W
Power input cooling	1100W
Current cooling	4.8 A
Heating capacity	2600W
Power input heating	1100W
Current heating	4.8 A
Maximum input power	1300W
Maximum current	5.8 A
Weight (kg)	31.5kg
Dimension (mm)	855L x 657W x 215H

Low profile, light & powerful with new inverter technology. 855mm length provides flexibility without sacrificing year-round comfort. True 'soft start' performance. Excellent performance with generator & battery/inverter power systems.

MOBILE AIR CONDITIONER HB9000



Power supply	220-240V/50Hz
Cooling capacity	2.2kw
Current cooling	4.2 A
Heating capacity	1.8 kW
Current heating	5.3 A
Electronic climate control	LED operating panel
Remote control	Sleep, timer, dehumidifying
Functions	Sleep mode, timer, touch pad
Electrical Rating (single phase)	230 volts
Weight (kg)	27.8kg
Dimension (mm)	652L x 442W x 287H

Finch Australia HB9000 Reverse Cycle Under Bunk Air Conditioner improves the internal temperature with hot/cold air without replacing the vehicle's original heating system.

MOBILE AIR CONDITIONER HB3400B



Power supply	1PH/230~240V/50Hz
Cooling capacity	3400W
Power input cooling	1350W
Current cooling	5.8A
Heating capacity	3000W
Power input heating	1250W
Current heating	5.4A
Maximum input power	1700W
Maximum current	7.4A
Weight (kg)	43kg
Dimension (mm)	1122L x 850W x 223H

Outstanding heating and cooling performance with low noise and vibration, the Belaire HB3400 is suitable for larger caravans & motorhomes.



(03) 9305 1555
 info@caravanandcampingaus.com
 caravanandcampingaus.com

Mark Strangis 0418 134 766 Roshan Chelvaratnam 0425 855 540
 Chad Helou 0458 048 999 James Buckland 0491 086 044



THETFORD

For over 60 years, Thetford has been your trusted companion on countless adventures. Pioneers in caravan appliances and off-grid accessories; Thetford fuels innovation that meets adventure. From the ground-breaking invention of the world's first Porta Potti to market-leading mobile sanitation systems, toilet care products, refrigeration, kitchen, and cooking appliances, Thetford has meticulously curated a comprehensive collection of solutions to equip your off and on the beaten path expeditions. Caravan and Camping Aus has the comprehensive range of Thetford available in warehouse, showroom & online



For full range visit thetford.com.au

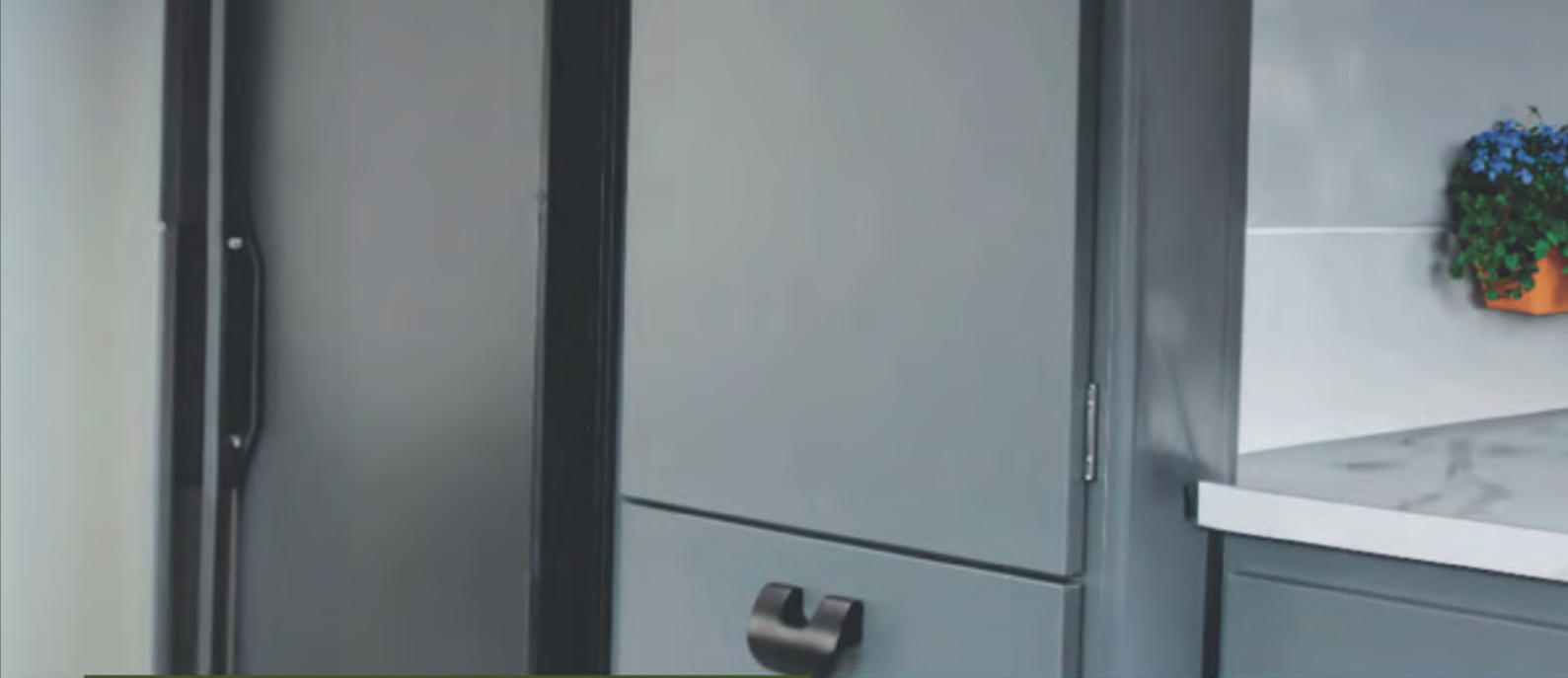

THETFORD

REFRIGERATORS

Extensively tested to meet the demands of the Australian caravanner and traveller. The Thetford refrigerator range available from Caravan and Camping Aus, offers unparalleled performance and reliability when on the road.

The Thetford range of refrigerators adhere to the highest quality standards. Thetford compressor and absorption refrigerators have a standard three year warranty. This provides customer reassurance when they have a thirst to hit the road and make new adventures.

SUPERIOR QUALITY DESIGN

- First-class cooling performance
- Maximised use of kitchen space
- Compliant with Australian Standards
- Extensive service network Australia-wide
- A Standard 3-year warranty on all products

REFRIGERATOR MODELS

- Compressor (12V) refrigerators
- Absorption (3-way) refrigerators



Thetford Compressor Refrigerators are optimised for 12-volt power and equipped with an internal ventilation system that rapidly cools the appliance, helping to maintain high performance in hot conditions. Featuring a power-saving night mode to minimise disruptive noises when it matters. For off-grid functionality, we recommend exploring supplementary power options such as batteries and vehicle solar panels, enabling you to enjoy uninterrupted operation wherever your adventures take you. The Thetford-developed Compressor Refrigerator sports an

T2152 T2175 T2208 T1274



Item Number	FIN-692939	FIN-692948	FIN-692966	FIN-692959
Dimensions incl. depth door (HxWxD)	1512x441x580mm	1256x544x613mm	1459x544x613mm	1534x614x684mm
Enclosure cut-out dimensions (HxWxD)	1504x420x527mm	1249x527x551mm	1464x534x566mm	1523x598x610mm
Total volume	150L	174L	224L	274L
Gross volume fresh food compartment	133L	140.5L	174L	202L
Gross volume frozen food compartment	17L	33.5L	47L	72L
Colour	Black	Black	Black	Black
Usable power source	12V DC	12V DC	12V DC	12V DC
Display	Capactive Touch	Capactive Touch	Capactive Touch	LED
Door shape	Flat - Framed	Flat - Framed	Flat - Door Pannel Included	Flat - Frameless
Door type hinging	Right (reversible)	Right (reversible)	Right (reversible)	Right (reversible)
Size door panel - 2mm thickness (HxW)	1394x399mm	700 x 499 mm (frozen food cabinet) 382 x 499mm (fresh food cabinet)	865x503mm	N/A
Door panel included	Yes	Yes	Yes	N/A
Energy consumption - kWh/24h	0.24kWh/24h (16°C) 0.7kWh/24h (32°C) 0.47kWh/24h (16 + 32/2°C)	0.3kWh/24h (16°C) 0.85kWh/24h (32°C) 0.62kWh/24h (16 + 32/2°C)	0.45kWh/24h	0.39kWh/24h (16°C) 0.86kWh/24h (32°C) 0.86kWh/24h (32°C)
Energy consumption - Ampere (Ah)	20Ah/24h (16°C) 58.3Ah/24h (32°C) 39Ah/24h (16 + 32/2°C)	25Ah/24h (16°C) 68.3Ah/24h (32°C) 46.7Ah/24h (16 + 32/2°C)	37.5Ah/24h	32.5Ah/24h (16°C) 70Ah/24h (32°C) 51.7Ah/24h (16 + 32/2°C)
Net. weight	38.8Kg	42.3Kg	53.5Kg	57Kg

efficient cooling system with an integrated venting system that effectively separates hot and cold air, maximizing overall efficiency and performance. Selected models include a split thermostat that creates the flexibility to independently adjust temperature settings for the fresh and frozen food compartments. All 12-volt refrigerator models feature a Day and Night mode for noise-free operation for quiet performance. The absence of external vents prevents any dust from entering your vehicle.

DE105 T2095



Item Number	FIN-6929565	FIN-692967
Dimensions incl. depth door (HxWxD)	765x523x566mm	906 x 398 x 680mm
Enclosure cut-out dimensions (HxWxD)	763x527x511mm	908 x 400 x 682mm
Total volume	105L	90.2L
Gross volume fresh food compartment	90L	80.2L
Gross volume frozen food compartment	15L	7.0L
Colour	Black	Black
Usable power source	12V DC	12V DC
Display	N/A	Internal, Direct Feedback
Door shape	Flat - Framed	Flat - Door Pannel Included
Door type hinging	Right (reversible)	N/A
Size door panel - 2mm thickness (HxW)	720x494mm	871 x 380mm
Door panel included	Yes	Yes
Energy consumption - kWh/24h	0.2kWh/24h (16°C) 0.7kWh/24h (32°C)	0.36 kW/24h
Energy consumption - Ampere (Ah)	45.0Ah/24h	28.8Ah/24h
Net. weight	32.5Kg	34Kg

Ideal for extended off-grid adventures, Thetford Absorption Refrigerators utilize a 3-way power source, offering the flexibility to operate on ULP gas, 12 volts (DC), or 240 volts (AC). These refrigerators are specifically designed for RVs, catering to our customers' needs as they explore the highways and byways. Perfectly suited for smaller and compact spaces, the Absorption Fridges excel in providing an ideal

cooling solution. They operate silently, thanks to the absence of moving parts in the cooling unit. Each model comes equipped with automatic energy source selection, which intuitively selects the most optimal available energy source for enhanced efficiency and a consistent supply. Additionally, all fridges are equipped with external fans to further amplify cooling performance.



	N414-A	N4175-A	N4208-A
--	--------	---------	---------



Item Number	FIN-692620SP	FIN-692612SP (LH) FIN-692613SP (RH)	FIN-692732SP (LH) FIN-692730SP (RH)
Dimensions incl. depth door (HxWxD)	1510x438.5x561mm	1250x546x628mm	1470x545x636mm
Enclosure cut-out dimensions (HxWxD)	570mm	606mm	585mm
Total gross volume	134L	166L	199L
Gross volume fresh food compartment	118.4L	135.5L	155.9L
Gross volume frozen food compartment	15.4L	30.3L	42.9L
Colour	Black	Black	Black
Energy source selection	Automatic	Automatic	Automatic
Usable power source	12V DC / 240V AC / Gas	12V DC / 240V AC / Gas	12V DC / 240V AC / Gas
Display	LCD (touch screen)	LCD (touch screen)	LCD (touch screen)
Ignition	Electric	Electric	Electric
Door shape	Flat - Framed	Curved - Framed	Curved - Framed
Door type hinging	Right (reversible)	Left or Right (reversible)	Left or Right (not reversible)
Size door panel - 2mm thickness (HxW)	950x394mm (cabinet) 453x394mm (drawer)	275x469mm (frozen food) 876x469mm (cabinet)	371.9x469mm (frozen food) 991.3x469mm (fresh food)
Door panel included	Yes	Yes	Yes
Energy consumption / gas	2.8kWh/24h (16°C) 5.5kWh/24h (32°C)	2.7kWh/24h (16°C) 5.4kWh/24h (32°C) 400g/24h (16°C) 600g/24h (32°C)	2.4kWh/24h (16°C) 6.2kWh/24h (32°C) 474g/24h (16°C) 550g/24h (32°C)
Total fans	3 (2 external & 1 internal)	3 (2 external & 1 internal)	3 (2 external & 1 internal)
Net. weight	38Kg	45Kg	53Kg
Required for installation - vents	2 x Vent 257x432mm	2 x Vent 281x533mm	2 x Vent 281x533mm
Required for installation - flue kit	White - 636974WH Black - 636974BK	White - 636974WH Black - 636974BK	White - 636974WH Black - 636974BK



VENTS AND FLU KITS

Achieve optimal cooling efficiency by outfitting your vehicle with Thetford wide selection of side and roof vents. Designed to meet the specific requirements of Thetford Absorption Refrigerators, these vents ensure proper ventilation for superior cooling performance. Available in white and black; the vents are available in a ranges of sizes and specifications to suit your RV needs, all available from our caravan and Camping Aus warehouse.



VENTS

Roof Cap Vent Base

Roof Cap Vent



Item Number	FIN-616319BWH	FIN-6222293CBW
Main dimensions (HxW)	281x533mm	257x432mm
Cut-out dimensions (HxW)	249x489mm	225x398mm
Net. weight	0.7Kg	0.6Kg
Colour	White / Black	White / Black
Applicable for	N4175-A (top and bottom)	N4141

Bottom Vent

Top Vent



Item Number	White - 63114084 Black - 63114027	White - 69110084 Black - 69110027
Main dimensions (HxW)	281x533mm	257x432mm
Cut-out dimensions (HxW)	249x489mm	225x398mm
Net. weight	0.7Kg	0.6Kg
Colour	White / Black	White / Black
Applicable for	N4175-A (top and bottom)	N4141

VENTS

Large Vent

N141 Vent



Item Number	White - 63114084 Black - 63114027	White - 69110084 Black - 69110027
Main dimensions (HxW)	281x533mm	257x432mm
Cut-out dimensions (HxW)	249x489mm	225x398mm
Net. weight	0.7Kg	0.6Kg
Colour	White / Black	White / Black
Applicable for	N4175-A (top and bottom)	N4141

FLU KITS

Ind. Flu Kit Black

Ind. Flu Kit White

Thetford Flu Kit



Item Number	FIN-636974BK	FIN-636974WH	FIN-637085
Colour	Black	White	N / A
Applicable for	Suitable for all models	Suitable for all models	Suits N3,N4,N5,N6 Series



COOKING APPLIANCES

Experience the convenience and culinary delight of home cooking right in your caravan or RV with our contemporary and efficient cooking appliances. Crafted to replicate the functionality and accessibility of your kitchen at home. Thetford cookers, hobs and ovens are meticulously designed and tested with premium materials which undergo rigorous safety testing. The Thetford range of products are all backed comprehensively by a three year warranty



K1520 - All in one combination unit with stove, grill and oven

This all-in-one combination unit with stove, grill and oven offers you all the convenience to make the best meals.

	Gas Only	Dual Fuel	Dual Fuel w/Fan forced oven
--	----------	-----------	-----------------------------



Item Number	SCK41134Z	SCK42134Z	SCK43134Z
Overall dimensions (HxWxD)	645x515x501mm	645x515x501mm	645x515x501mm
Enclosure cut-out dimensions (HxWxD)	646x496x493mm	646x496x493mm	646x496x493mm
Total heat input	9.75kW	7.45kW	7.45kW
Gas hotplate burners	1 x 0.89kW 3 x 1.72kW	1 x 0.89kW 2 x 1.72kW	1 x 0.89kW 2 x 1.72kW
Electric hotplate (220 - 240V ~ 50Hz)	N/A	145mm 1.025kW 4.5A (hotplate)	145mm 1.040kW 4.6A (hotplate & fan)
Grill burner	1.65kW	1.65kW	1.65kW
Oven burner	1.53kW	1.53kW	1.53kW
Ignition	12V	12V	12V
Oven capacity (HxWxD)	34L 250x380x360mm	34L 250x380x360mm	34L 250x380x360mm
Grill capacity (HxWxD)	15L 130x380x303mm	15L 130x380x303mm	15L 130x380x303mm
Net. weight	24.5Kg	25.5Kg	27.5Kg
Features	Flame failure device on valves, glass lid with automatic shut off, oven light, oven shelf, multi-functional pan, detachable handle and pan trivet		

K1540 Stove and Grill Combination

This compact grill and hob combination offers multi-function versatility in a durable, light-weight and easy-to-clean unit.

Gas Only Dual Fuel



Item Number	SHG41134Z	SHG42134Z
Overall dimensions (HxWxD)	310x515x501mm	310x515x501mm
Enclosure cut-out dimensions (HxWxD)	312x496x493mm	312x496x493mm
Total heat input	7.70kW	6.0kW
Gas hotplate burners	1 x 0.89kW 3 x 1.72kW	1 x 0.89kW 2 x 1.72kW
Electric hotplate (220 - 240V ~ 50Hz)	N/A	145mm 1.025kW / 4.5A
Grill burner	1.65kW	1.65kW
Ignition	12V	12V
Grill capacity (HxWxD)	15L 130x380x303mm	15L 130x380x303mm
Net. weight	14.5Kg	15.5Kg
Features	Flame failure device on valves, glass lid with automatic shut off, multi-functional pan, detachable handle and pan trivet	

Duplex MK3 - Oven and Grill Combination

Enhance your kitchen with a Thetford Duplex. The Duplex is a high quality combined oven and grill, with easy to clean stainless steel interior.



Item Number	SOG70814Z
Overall dimensions (HxWxD)	445x456x440mm
Enclosure cut-out dimensions (HxWxD)	438x445x490mm
Total heat input	1.6kW*
Grill burner	1kW
Oven burner	1.6kW
Ignition	12V
Oven capacity (HxWxD)	36L 258x380x363mm
Net. weight	13.5Kg
Features	Flame failure device on valves, oven shelf, multi-functional pan, detachable handle and pan trivet

Triplex MK3 - Compact all in one combination unit with stove, grill and oven

If space is limited, this oven, grill and hob combination offers you all the quality features to make the best meals.

Gas Only Dual Fuel



Item Number	SOH70933Z	SOH71934Z
Overall dimensions (HxWxD)	468x463x500mm	468x463x500mm
Enclosure cut-out dimensions (HxWxD)	468x448x493mm	463x445x493mm
Total heat input	7.6kW	6.0kW
Gas hotplate burners	2 x 1.8kW 1 x 2.4kW	1 x 0.89kW 2 x 1.72kW
Electric hotplate (220 - 240V ~ 50Hz)	N/A	145mm 1.025kW / 4.5A
Grill burner	1.6kW	1.65kW
Oven burner	1.5kW	1.5kW
Ignition	12V	12V
Oven capacity (HxWxD)	36L 257x380x362mm	

THETFORD

HOBS

Thetford Hobs provide user friendly and practical cooking experience when travelling on the road. Thetford Hobs feature domestic sized knobs and sufficient space for pans of all sizes. The Thetford range is renowned for its high standards, this is why Caravan and Camping Aus are proud to offer the range as the materials are of the highest standard and are subjected to rigorous testing.



Topline 902 Hob



Topline 922 Hob



THETFORD

Item Number	SHB90290Z	SHB92290Z
Overall dimensions (HxWxD)	50x305x500mm	95x305x500mm
Worktop cut-out dimensions (WxD)	274x482mm	285x485mm
Total heat input	2.3kW (shared between both zones)	3.0kW
Gas hotplate burners	N/A	2 x 1.5kW
Induction	1 x rapid burner (1.8 / 2.3kW) B* 1 semi rapid burner (1.4 / 1.8kW) B*	N/A
Ignition	N/A	12V
Power	2.3kW (6A / 10A / 13A)	N/A
Net. weight	5.4Kg	4.8Kg
Features	240V Electrical supply, pan detection, auto heat up, safety indication if glass is hot, child safety lock	Modern satin chrome knobs, flame failure device on valves

Topline 169 Hob

The Topline hob is a modern, flush-mounting hob with a glass lid that covers the burners for a clean look. It has an electric 12V DC ignition and detachable pan rests.



Item Number	SHB16963Z
Overall dimensions (HxWxD)	105x546x482mm
Worktop cut-out dimensions (WxD)	538.5x473mm
Total heat input	5.4kW
Gas hotplate burners	2 x 1.5kW \ 1 x 2.4kW
Ignition	12V
Net. weight	10.7Kg
Features	Flame failure device on valves, black glass lid, flush bench top fitment and automatic shut off on lid

Argent Hob

The Argent hob is a stainless steel hob with detachable pan stands that are easy to clean and enamelled burner lids. Available in a 3 and 4 Burner model.



Item Number	SHB1457ZZ
Overall dimensions (HxWxD)	110x570x470mm
Worktop cut-out dimensions (WxD)	545x433mm
Total heat input	5.4kW
Gas hotplate burners	2 x 1.5kW \ 1 x 2.4kW
Ignition	12V or AA Battery (1.5V)
Net. weight	6.4Kg
Features	Flame failure device on valves, spark ignition, black glass lid and automatic shut off on lid

Basic Line Triangular Hob

The Basic Line Triangular Hob is a stainless steel hob that has an electric 12V spark ignition and detachable pan stands that are easy to clean.



Item Number	SHB33015Z
Overall dimensions (HxWxD)	100x480x480mm
Worktop cut-out dimensions (WxD)	453x460mm
Total heat input	4.5kW
Gas hotplate burners	3 x 1.5kW
Ignition	12V
Net. weight	4.1Kg
Features	Flame failure device on valves, 12V spark ignition, black glass lid and automatic shut off on lid

Topline Hybrid Hob

The Topline Hybrid brings a combination of induction and gas cooking. Made of the highest quality Schott Ceran black glass, The Topline Hybrid Hob is both sleek and easy to clean.



Item Number	SHB98150Z
Overall dimensions (HxWxD)	100 x 500 x 380 mm
Worktop cut-out dimensions (WxD)	480 x 360 mm

353 Series - Combination Unit

The 353 Combo unit comes with left or right handed sink. A versatile choice, the 353 Combination Unit is a good choice for a slide-out kitchen. The split glass lid has a clean and organic shaped look, that can be used as extra work space when the lids are down.



Item Number	SCU353000Z (LH) SCU353100Z (RH)
Overall dimensions (HxWxD)	160x980x410mm
Worktop cut-out dimensions (WxD)	962x389mm
Total heat input	4.9kW
Gas hotplate burners	1 x 1.0 (kW) 1 x 1.5 (kW) 1 x 2.4 (kW)
Depth bowl	12V
Sink capacity	4.1Kg
Surface finish	Brushed stainless
Pan support	2 pieces - cast iron
Weight	10.7Kg

THETFORD

SINKS

Experience the convenience and culinary delight of home cooking right in your caravan or RV with our contemporary and efficient cooking appliances. Crafted to replicate the functionality and accessibility of your kitchen at home. Thetford cookers, hobs and ovens are meticulously designed and tested with premium materials which undergo rigorous safety testing. The Thetford range of products are all backed comprehensively by a three year warranty



Enamelled Kitchen Centre

The Enamelled Kitchen Centre is the latest addition to the Thetford sink family. This modern, high quality sink comes with a black glass lid, plastic wash bowl, chopping board, draining board and draining rack.



Item Number	SBL1054Z
Overall dimensions (HxWxD)	153x360x470mm
Worktop cut-out dimensions (WxD)	335x430mm
Inside bowl dimensions	99x290x368mm
Sink capacity	11L
Net. weight	5.8Kg

PERFECT MATCH

Topline 922 Hob



Kitchen Centre

Complete kitchen sink set, including plastic wash bowl, chopping board, draining board and draining rack. Accessories fit inside the sink when not in use, which makes the Kitchen Centre a beautiful space saver.



Item Number	SBL1011Z
Overall dimensions (HxWxD)	153x360x470mm
Worktop cut-out dimensions (WxD)	335x430mm
Inside bowl dimensions	99x290x368mm
Sink capacity	11L
Net. weight	5.2Kg

PERFECT MATCH

Topline 902 Hob



Argent Sink

This Argent sink is available with a Left or Right Handed drain and comes with a black glass lid.



Item Number	SSK1073Z (LH) SSK1074Z (RH)
Overall dimensions (HxWxD)	152x630x470mm
Worktop cut-out dimensions (WxD)	605x415mm
Inside bowl dimensions	100x290x368mm
Sink capacity	9.6L
Net. weight	4.8Kg

PERFECT MATCH

Argent Hob



Round Sink

This Stainless steel round sink comes with black glass lid.



Item Number	SBL3013Z
Overall dimensions (HxWxD)	405x145mm
Worktop cut-out dimensions (WxD)	390mm
Inside bowl dimensions	328x93mm
Sink capacity	7.4L
Net. weight	2.4Kg

PERFECT MATCH

Triangular Hob



SERVICE DOORS

Enhance accessibility to designated spaces such as the luggage compartments, gas cylinders, generator, barbecues, or the Cassette Toilet through the installation of a convenient hatch or door. Thetford Service Doors are purpose designed and crafted with utmost durability using top - quality lightweight plastics. With a double seal for superior insulation against external weather conditions and a secure push - button lock, your door will provide safety and security throughout your travels.



CASSETTE

Designed for outdoor adventures. Compact, lightweight and easy to transport. Features include a flushing system, a high capacity waste - holding tank, ergonomic seating and versatile usage. Experience convenience and comfort wherever you go, embracing the great outdoors without compromising on sanitation.



ADVANTAGES

- UV resistant
- Double seal ensures optimum insulation
- For horizontal or vertical installation
- Special push-button locks allow the doors to be closed securely, so they can't spring open unexpectedly
- Easy self-installation

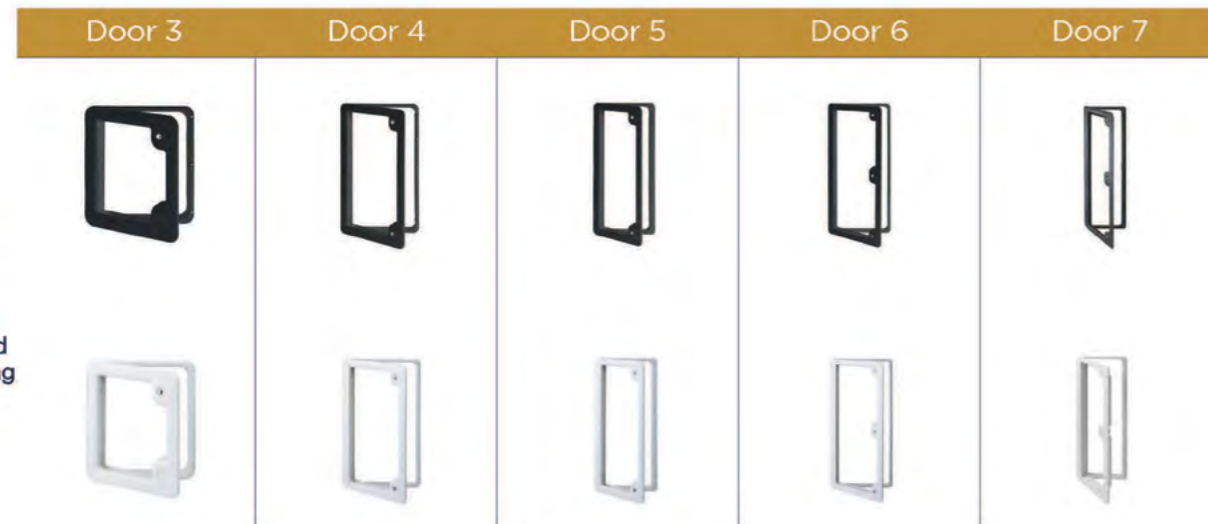

Item Number	White - 2680584 Black - 2680527	White - 2681884 Black - 2681827	White - 2682484 Black - 2682427	White - 2686484 Black - 2686427	White - 2644584 Black - 2644527
Application	Standard door for the Cassette Toilet and compact general door	Door for gas cylinders generators and barbecue	General luggage door	Wider door for large pieces of general luggage	Wider door for large pieces of general luggage
Main dimensions (HxW)	386x342mm	703x395mm	786x344mm	1039x467mm	1109x347mm
Door/opening dimensions (HxW)	330x280mm	630x330mm	730x280mm	980x400mm	1051x282mm

Electric Swivel

FIN-



Dimensions (HxWxD)	Seating height	Colour	Bowl material	Net weight	Flushing system	Capacity of flush-water tank	Removable Waste tank Mechanism
534x394x580mm	492mm	White	Plastic	72kg	Electric	-	No

Required for installation:



Service Door
White - 2680584
Black - 2680527



Waste Tank
18L waste-holding tank capacity.
Waste-holding tank on wheels.

Ceramic Bowl Swivel

FIN-



Dimensions (HxWxD)	Seating height	Colour	Bowl material	Net weight	Flushing system	Capacity of flush-water tank	Removable Waste tank mechanism
750x417x600mm	479mm	White	Ceramic	17.1kg	Electric	-	Yes

Required for installation:



Service Door
White - 2680584
Black - 2680527



Waste Tank
17.5L waste-holding tank capacity.
Waste-holding tank on wheels.

Left Hand Cassette Right Hand Cassette

Left Hand
Right Hand

FIN-
FIN-



Dimensions (HxWxD)	Seating height	Colour	Bowl material	Net weight	Flushing system	Capacity of flush-water tank	Removable Waste tank mechanism
512x670x400mm	473mm	White	Plastic	8.8kg	Electric	15L	Yes

Required for installation:



Service Door
White - 2680584
Black - 2680527



Waste Tank
19.3L waste-holding tank capacity.
Waste-holding tank on wheels



Designed for outdoor adventures. Compact, lightweight and easy to transport. Features include a flushing system, a high capacity waste - holding tank, ergonomic seating and versatile usage. Experience convenience and comfort wherever you go, embracing the great outdoors without compromising on sanitation



Practical solutions that effortlessly boost both functionality and comfort, providing that extra touch of assistance to effectively address specific and niche needs.

The Fresh Up Set

Maintain a fresh appearance and optimal performance of your Thetford toilet with the Thetford Toilet Fresh-Up Set. This convenient set features replacement parts for two essential components of your existing RV toilet system:

- A new waste-holding tank
- New seat and cover

Available for, Thetford Cassette Toilets C2/C3/C4*, C200, C220, C400*, ceramic and plastic bowl C250/C260.



*For left and right models.

Hold Down Kit

The Thetford Hold Down Kit is designed to securely fasten and stabilise your RV toilet to the floor. It ensures that the toilet remains in place during travel or movement, preventing any unwanted shifting or loosening. This kit is an essential accessory that helps maintain the stability and reliability of your RV's toilet system. The Hold-Down Kit is compatible with Porta Potti models 145, 345 and 335. The floor plate (9241507) is recommended for securing your Porta Potti 565.



Toilet Thetford Porta Potti Bags

Designed for easy transport and storage, the Porta Potti Carry Bag makes it easy to move your Porta Potti on the go.

- Maximum carrying weight of 30kg
- Easy Cleaning, without shrinkage (washable) max 40 degrees)
- Easy and convenient carrying



Porta Potti 145 Porta Potti 165 Porta Potti 335 Porta Potti 345 Porta Potti 365 Porta Potti 565P & 565E

	Porta Potti 145	Porta Potti 165	Porta Potti 335	Porta Potti 345	Porta Potti 365	Porta Potti 565P & 565E
Comfort Class	●●●○○	●●●○○	●●●○○	●●●○○	●●●●●	●●●●●+
Size	Medium	Large	Small	Medium	Large	Luxury Large
Dimensions (HxWxD)	330x383x427mm	414x383x427mm	313x342x382mm	330x383x427mm	414x383x427mm	448x388x450mm
Seat Height	324mm	408mm	308mm	324mm	408mm	443mm
Flushing System	Bellow Pump	Bellow Pump	Piston Pump	Piston Pump	Piston Pump	565P - Piston Pump 565E - Electric Pump
Level Indicator Display for the waste-holding tank	No	No	Yes	Yes	Yes	Yes
Capacity of the waste-holding tank	12L	21L	10L	12L	21L	21L
Level Indicator display for the flush-water tank	No	No	No	No	No	Yes
Capacity of flush-water tank	15L	15L	10L	15L	15L	15L
Net weight	3.6Kg	3.8Kg	3.3Kg	3.8Kg	4.0Kg	565P - 4.9Kg 565E - 5.0Kg
Additional Information	-	Option on floor attachment (Hold down kit, partnumber)	Porta Potti 335 comes with a hold down kit	-	Option on floor attachment (Hold down kit, part number 92922111)	Toilet paper holder with option for a grey floor plate (partnumber 9241507)
Partnumber	92828	92806	92828	92814	92820	565P - 92305 565E - 92306



CARE FOR YOUR WASTE TANK



TOILET & BATHROOM CARE

Thetford toilet care products minimize the chances of damage, early deterioration and other issues related to motorhome lavatories. These products are conveniently accessible at renowned caravan and motorhome dealerships, along with specialised camping stores. With a wide selection of cleaning and care items, we guarantee optimal bathroom hygiene and comfort.

Formulated to efficiently clean and prolong the lifespan of your Thetford Toilet. Thetford Additives offer exceptional odour control, waste liquefaction, and a reduction of gas accumulation. Our toilet fluids and maintenance items are certified in accordance with Australian standards in terms of quality management and are thoroughly tested in Thetford laboratories before going to market.

The Aqua Kem Collection is available in sachets or concentrate liquids. Aqua Kem Blue offers three scents in concentrate form, while, Aqua Kem Green offers an eco-conscious alternative that can be used in septic tanks. Aqua Kem Green is recommended when using a septic tank to maintain the health of the tank.

Aqua Kem Blue Concentrated - 780ml



- ✓ Outstanding odour control
- ✓ Liquefies waste for easier tank emptying
- ✓ Convenient small bottle, less weight
- ✓ Pine scent

Aqua Kem Blue Concentrated Lavender - 780ml



- ✓ Outstanding odour control
- ✓ Liquefies waste for easier tank emptying
- ✓ Reduction of gas build up
- ✓ Lavender scent

Aqua Kem Blue Concentrated Eucalyptus - 780ml



- ✓ Outstanding odour control
- ✓ Liquefies waste for easier tank emptying
- ✓ Convenient small bottle, less weight
- ✓ Eucalyptus scented

Aqua Kem Blue Sachets - 15pk



- ✓ Outstanding odour control
- ✓ Liquefies waste for easier tank emptying
- ✓ Convenient small bottle, less weight
- ✓ Pine scented

Aqua Kem Green Sachets - 12pk



- ✓ Outstanding odour control
- ✓ Liquefies waste for easier tank emptying
- ✓ Reduction of gas build up
- ✓ Lavender scent

Aqua Kem Green - 750ml



- ✓ Outstanding odour control
- ✓ Liquefies waste for easier tank emptying
- ✓ Convenient small bottle, less weight
- ✓ Pine scented

CARE FOR ALL COMPONENTS

It's the small things that matter when maintaining your Thetford Toilet. Additives that care for your flush water, grey water, and toilet bowl are necessary for the overall toilet experience when you're travelling on the road.



For the Grey Water Tank

Duo Tank Cleaner Concentrated - 800ml



- ✓ Removes scale, encrusting, and grease deposits
- ✓ No scrubbing is required
- ✓ Technical parts inside the tanks are cleaned as well
- ✓ Prolongs the lifespan of the tankholding tank
- ✓ Prevents malfunctions or damage to the waste-holding tank

PERIODICAL USE

Grey Water Fresh Concentrated - 800ml



- ✓ Reduces deposit formation in the grey water tank
- ✓ Outstanding grey water odour control
- ✓ Keeps the grey water fresh and clean for longer
- ✓ Odour free discharging of the grey water tank
- ✓ Convenient small bottle holding tank
- ✓ Prevents malfunctions or damage to the waste-holding tank

REGULAR USE

CARAVAN AND CAMPING AUS HAS ALL THE PRODUCTS YOU NEED FOR YOUR ADVENTURE

For the Toilet Bowl

Aqua Rinse Spray - 750ml



- ✓ Septic tank safe
- ✓ Coats the toilet bowl with a protective layer for a smoother flush
- ✓ Prevents staining
- ✓ Smells fresh after spraying
- ✓ Saves water as fewer flushes are required

Toilet Bowl Cleaner - 750ml



- ✓ Safely removes hard water and soil
- ✓ Deposits from both plastic and ceramic toilet bowls
- ✓ Leaves a protective layer behind
- ✓ Pleasant fresh scent
- ✓ Safe for plastics, ceramics and rubber toilet seals

Aqua Soft Toilet Paper - 6pk



- ✓ Dissolves quickly
- ✓ Prevents clogging
- ✓ Super-soft toilet paper
- ✓ Easier to empty waste-holding tank
- ✓ Prevents malfunctions or damage to waste-holding tank

For Daily Maintenance

Seal Lubricant - 200ml



- ✓ Protects, lubricates, ensures pliability
- ✓ For periodical care and maintenance
- ✓ Safe for plastics
- ✓ Can also be used on door seals, locks, hinges, awning rails and bicycles
- ✓ Saves water as fewer flushes are required

Bathroom Cleaner - 500ml



- ✓ Powerful cleaning agent for daily maintenance
- ✓ Safe for all plastics surfaces
- ✓ Active foam removes calcium deposits
- ✓ For daily cleaning
- ✓ Effective on lime scale and soap scum

For the Flush Water Tank

Aqua Rinse Concentrate - 700ml



- ✓ Septic Tank Safe (Thetford anaerobic biodegradability test)
- ✓ Safe for both plastic and ceramic toilet bowls
- ✓ Prevents limescale build-up in your flush water tank
- ✓ Keeps your toilet bowl shinier
- ✓ Ensures a more effective and smoother flush

Plumbing

Plumbing



**MICA 3-WAY FILTER
KITCHEN TAP SINK MIXER**
BRUSHED NICKEL SMP-5-FLT-BN



**MICA SOFT-SQUARE
KITCHEN TAP SINK MIXER**
CHROME SMP-5-90-RGN



**MICA FLUTED
ROBE HOOK**
FRENCH GOLD
1153-S-P-NR-FG



**MICA TALL BASIN TAP
SINK MIXER STRAIGHT**
BLACK BMSP-51-TALL-BLK



**MICA SHORT BASIN TAP
SINK MIXER STRAIGHT**
CHROME BMSP-51



**MICA SHORT BASIN TAP
SINK MIXER CURVED SPOUT**
FRENCH GOLD BMC-P-5-FG



**MICA FLUTED
SINGLE TOWEL RAIL
UNIVERSAL LENGTH**
GUNMETAL 1124-800-P-NR-GM



**Mica Fluted Double
Towel Rail Universal
Length**
BRUSHED NICKEL
1148D-800-P-NR-BN



MICA ROBE HOOK
BLACK
1153-S-P-BLK



**MICA SHOWER TAP
FLICK MIXER**
BRUSHED NICKEL
SHMP-5-BN



**MICA TALL BASIN TAP SINK
MIXER CURVED SPOUT**
CHROME BMC-P-5-TALL



**MICA GOOSENECK
KITCHEN TAP SINK MIXER**
FRENCH GOLD SMP-5-FG



**MICA WIDE HAND
SHOWER HEAD AND
1500MM HOSE**
BRUSHED NICKEL
R01-V2-SHRT-BN



**MICA SLIM HAND
SHOWER HEAD
AND 1500MM HOSE**
FRENCH GOLD
R03-V2-SHRT-FG



**MICA FLUTED
TOILET PAPER
ROLL HOLDER**
GUNMETAL
1111-P-NR-GM



**MICA FLUTED
ROUND TOWEL
RING**
GUNMETAL
1104-P-NR-GM



**MICA ROUND
HAND TOWEL
RING**
GUNMETAL
1104-P-GM



**MICA SHOWER
ROUND HEAD
AND RAIL**
GUNMETAL
R01-R-P-GM



**FOMOS BLACK GRANITE
COMPOSITE SINGLE BOWL
SINK WITH DRAINER**
860X500MM
SNK-8650DN-BLK



**LUMINARE SINGLE BOWL
SINK 760 X 440MM**
STAINLESS STEEL SNK-P-7644

For full range visit
bella-vista.net.au

GUARANTEE OF QUALITY



RANGE

Our LED products' quality and innovative features are tested and trusted by Australian manufacturing companies that incorporate our LED Brand into their product designs. Our clients put our auto lights through some of the harshest conditions before they are used to ensure that their customers receive the best product on the market that will exceed all expectations.

At Caravan and Camping Aus we believe in functional innovation, long-lasting quality and value for money in all of the products we sell to benefit our OEM's and end customers.



Item: **CCA-GH12B**

LED Autolamp Grab Handle Light Black Bargman Style

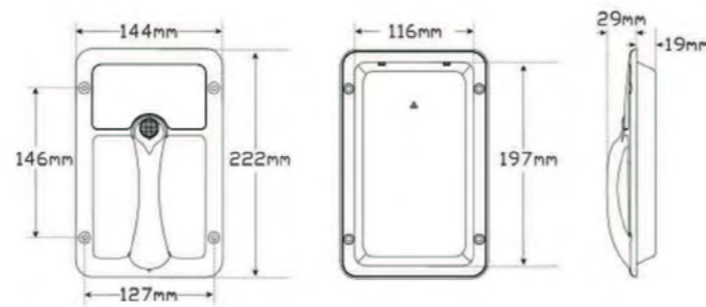

LED Autolamp 12V Slimline Stop/Tail/Indicator Taillight

CCA-285BAR12: 285x25x10mm

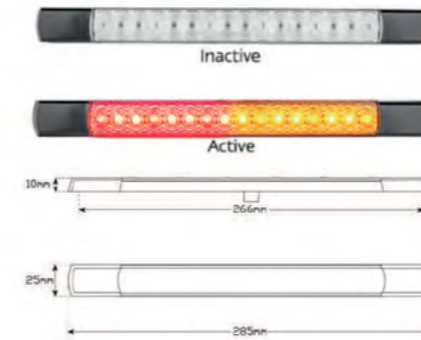

LED Autolamp 12V Stop/Tail/Indicator Taillight

CCA-407BARR Clear Lens Black 407x147x35mm

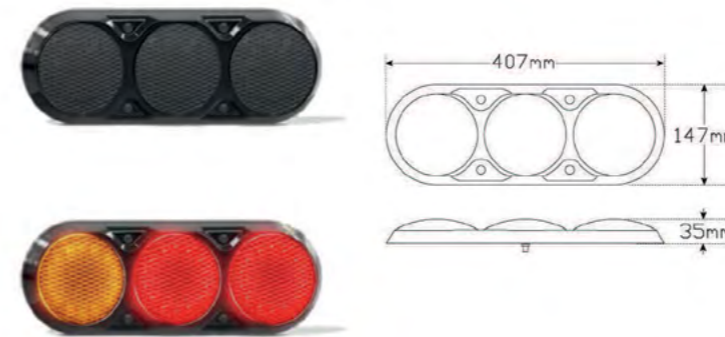

LED Autolamp 12V Slim Line Stop/Tail/Indicator Tail light

CCA-380BAR12: Black 428x97x22mm

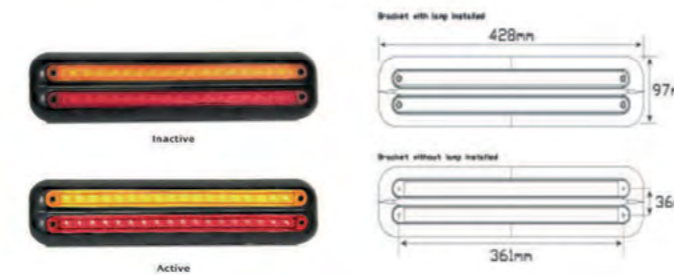

LED Autolamp 12V Round Interior Cool White Lamp

CCA-7515CB: Chrome Bezel



LED Autolamp 12V Stop/Tail/Indicator Taillight Clear Lens

CCA-407BARRC: Black 407x147x35mm

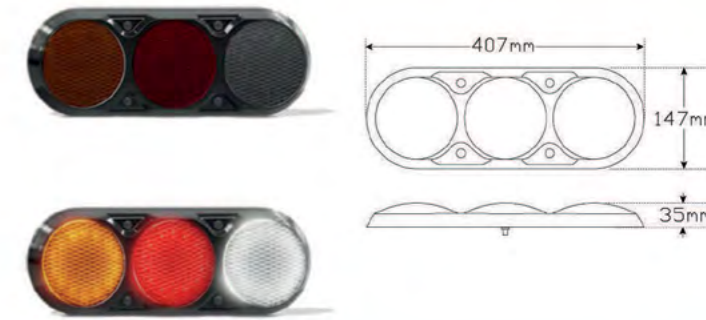

LED Autolamp Triple Surface Tail lamp Mount Housing

CCA-102B3B: Black Suit 102 Series



LED Autolamp Red/Amber Side Marker

CCA-1458ARM: Red/Amber 75x38x32mm



LED Autolamp Large Round Interior/Exterior Lamp

CCA-13118WM-SW: 145x30x145mm

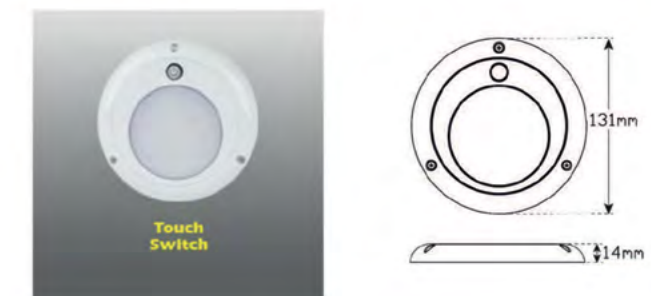

LED Autolamp 102 Series 12V Round Indicator Lamp

CCA-102AC: 130mm Clear Lens



LED Autolamp 12V Dual Function Awning Light

CCA-2345AWB: White/Yellow 443x23x24mm



LED Autolamp White Reflector with Mount Bracket

CCA-7035WB: Black 93x35x7mm (Box of 100)



LED Autolamp 12V Stop/Tail/Indicator Taillight

CCA-82BARR: 281x101x30mm

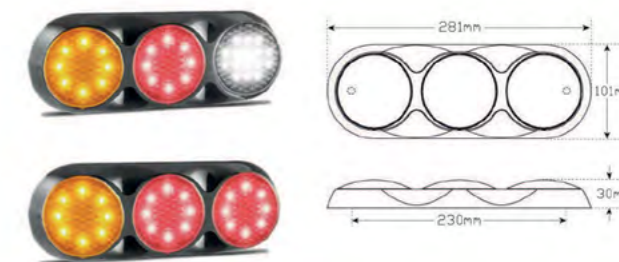

LED Autolamp RHS 12V Stop/Tail/Indicator Taillight

CCA-3856ARRB: 387x105x31mm

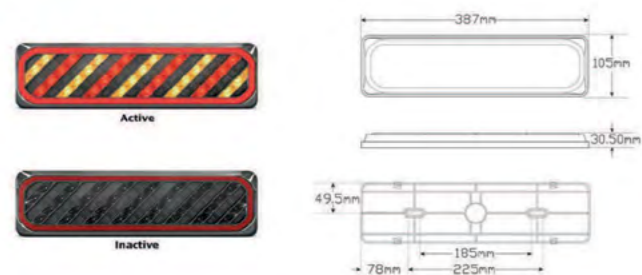

LED Autolamp LHS 12V Stop/Tail/Indicator Taillight

CCA-3856ARRLB: 387x105x31mm



LED Autolamp 12V Round Rear Stop/Tail Lamp Taillight

CCA-82RCB: Red 80mm

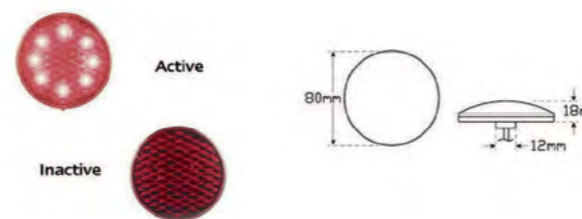

LED Autolamp 12V Round Rear Stop/Tail Lamp Taillight

CCA-82ACB: Amber 80mm

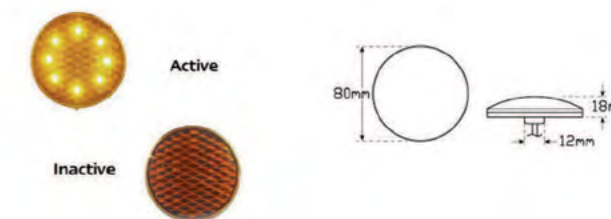

LED Autolamp Rear Marker

CCA-1458RM: Red 74x38x32mm

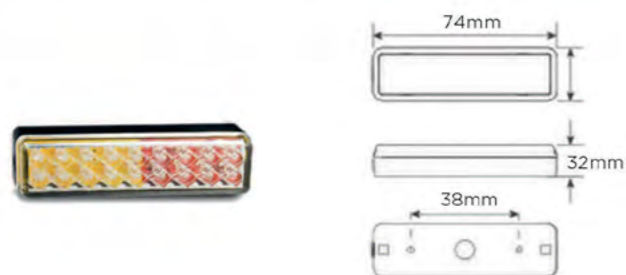

LED Autolamp 12V LH/RH Direction Stop/Tail/Indicator

CCA-215ARLP2: Reflector Taillight 215x105x30.5mm

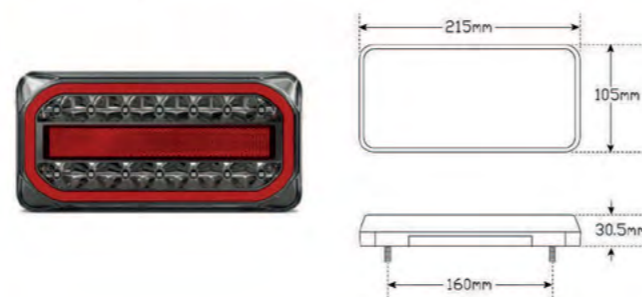

LED Autolamp 12V Round Rear Stop/Tail Lamp Taillight

CCA-82WCB: White 80mm

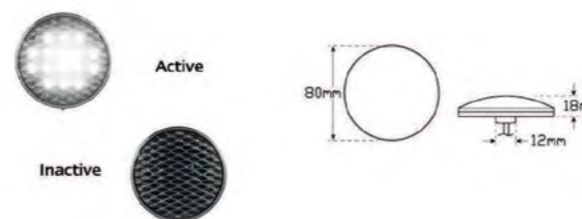

LED Autolamp Triple Surface Taillamp Mount Housing

CCA-82B3B: Black Suit 82 Series



LED Autolamp Amber Reflector with Mount Bracket

CCA-7035AB: Black 93x35x7mm (Box of 100)



LED Autolamp Red Reflector with Mount Bracket

CCA-7035RB: Black 93x35x7mm (Box of 100)



LED Autolamp 12V/24V Maxilamp Tail/Indicator/Reflector

CCA-MAXILAMP3XR3M: Black Chrome 407x147x35mm



LED Autolamp 12V/24V Maxilamp Tail/Indicator/Reflector

CCA-MAXILAMP3XRWB: Black Chrome 407x147x35mm



LED Autolamp White Front Marker

CCA-1458WM: 73x38x32mm

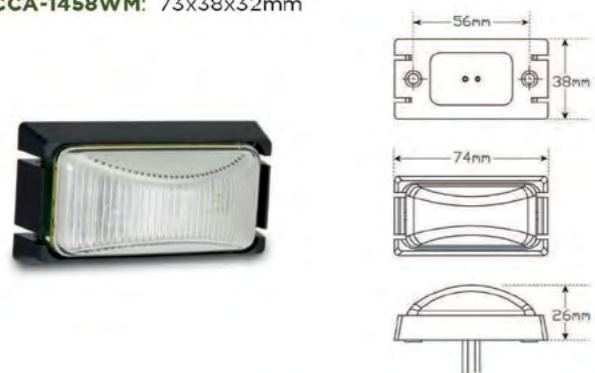

LED Autolamp 12V Strip Stop/Tail/Indicator Taillight

CCA-235BAR12: Black 258x82x17mm



LED Autolamp Amber Reflector Stick On

CCA-7030AB: 70x30x6mm (Box of 100)

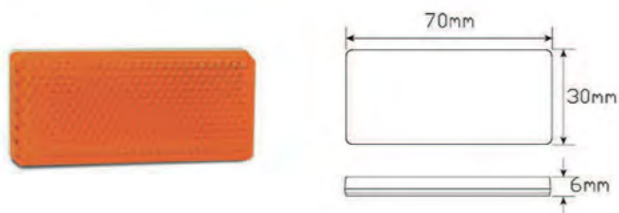

LED Autolamp Red Reflector Stick On

CCA-7030RB: 70x30x6mm (Box of 100)

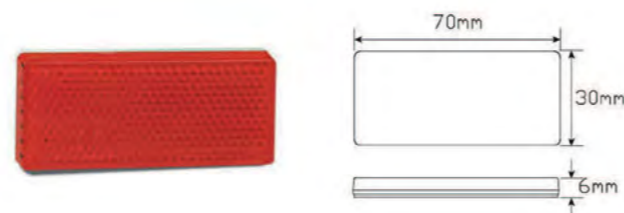

LED Autolamp White Reflector Stick On

CCA-7030WB: 70x30x6mm (Box of 100)

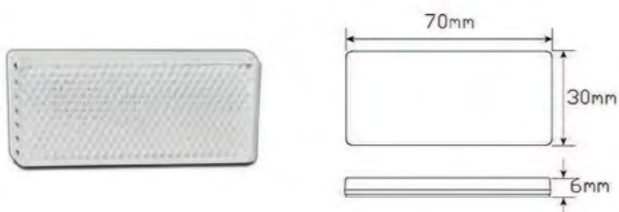

LED Autolamp 12/24V Amber Side Marker with Reflector

CCA-EU38AMHDB: 100x38x13mm

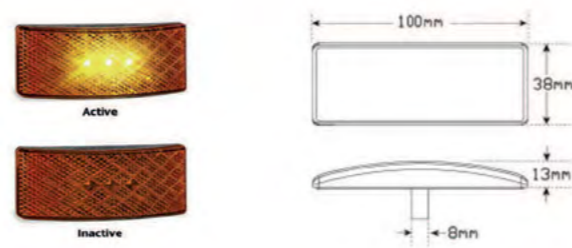

LED Autolamp 12/24V Red Side Marker with Reflector

CCA-EU38RMHDB: 100x38x13mm

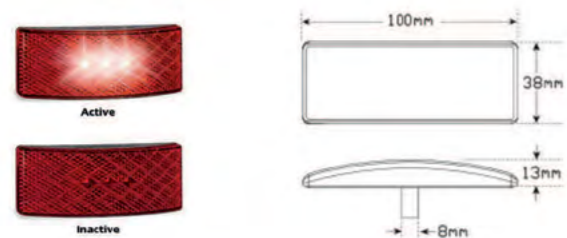

LED Autolamp 12/24V White Side Marker with Reflector

CCA-13118WM-SW: 145x30x145mm



LED Autolamp 12V/24V Amber Side Marker with Reflector

CCA-EU38BAMHDB: 3M Adhesive 100x38x13mm



LED Autolamp Red/Amber Side Marker

CCA-1458ARM: Red/Amber 75x38x32mm



LED Autolamp 12V/24V Red Side Marker with Reflector

CCA-EU38RMHDB: 3M Adhesive 100x38x13mm

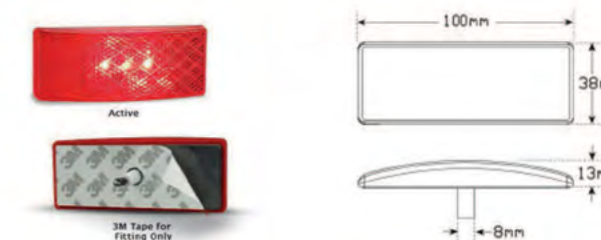

LED Autolamp 102 Series 12V Round Tail Lamp Clear Lens

CCA-102RC: White 130mm



LED Autolamp 102 Series 12V Round Tail Lamp Clear Lens

CCA-102A: Amber 130mm

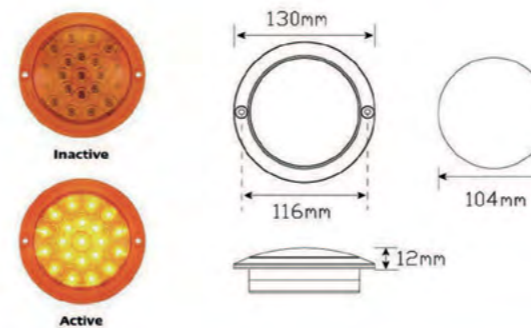

LED Autolamp 102 Series 12V Round Tail Lamp Clear Lens

CCA-102R: Red 130mm

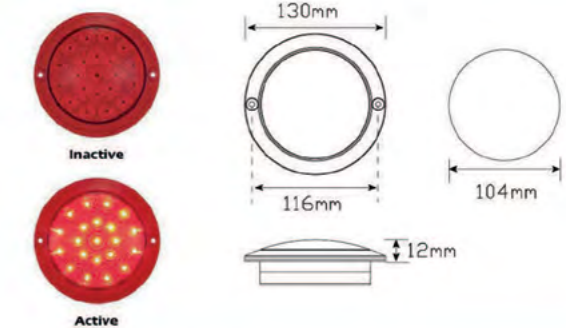

LED Autolamp 12V Strip Red Stop/Tail Taillight

CCA-235R12: 237x25x3mm



LED Autolamp 12V Strip Red Stop/Tail/Indicator Taillight

CCA-235BBST112/2: 298x46x17mm



LED Autolamp Single Surface Mount Bracket

CCA-235B1B: Suits 235 Series Black



LED Autolamp Single Chrome Bracket

CCA-235C1B: To suit 235 Series Strip Lamps



LED Autolamp 12V Red Round Stop/Tail Taillight

CCA-102RBC: Black Chrome 130mm

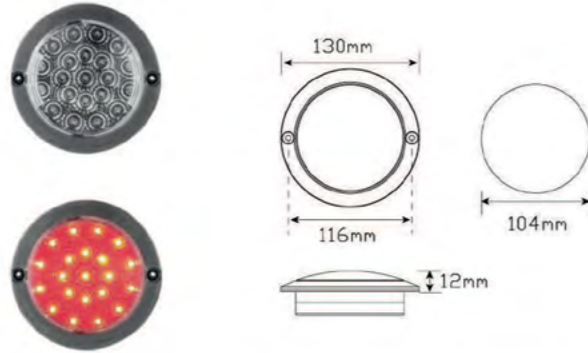

LED Autolamp 12V Amber Round Stop/Tail Taillight

CCCA-102ABC: Black Chrome 130mm

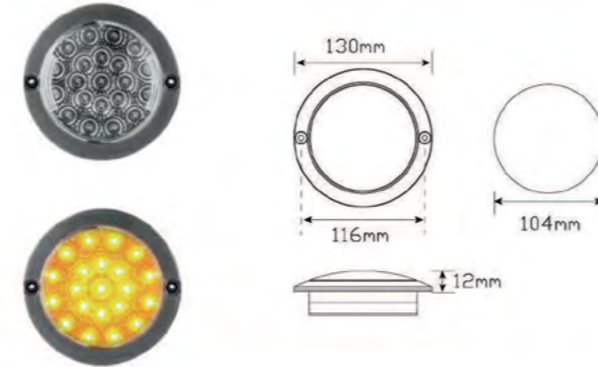

LED Autolamp 12V Round Stop/Tail Taillight

CCCA-102WBC: Black Chrome 130mm

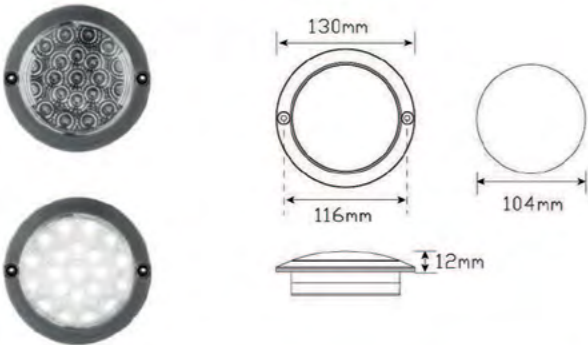

LED Autolamp 12V/24V Amber Side Marker

CCA-44AMEB: Indicator with Reflector 100x44x12

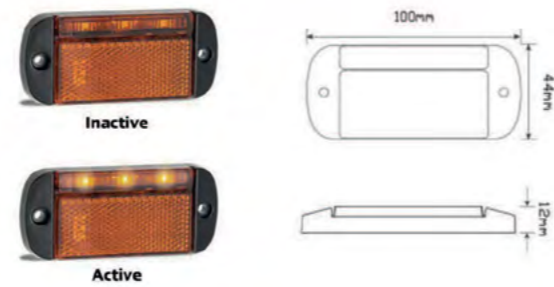

LED Autolamp 12V/24V Red Side Marker

CCA-44WMEB: Indicator with Reflector 100x44x12

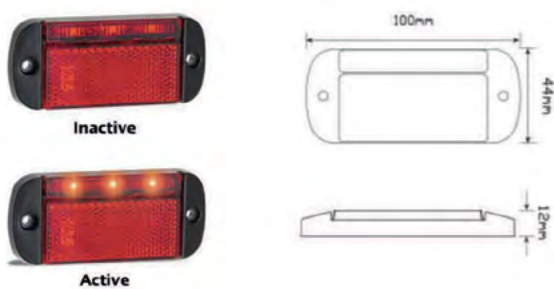

LED Autolamp 12V/24V Red Side Marker

CCA-44WMEB: Indicator with Reflector 100x44x12

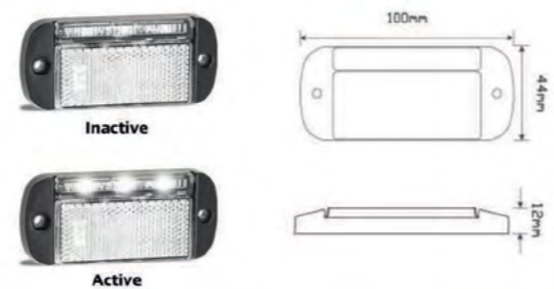

LED Autolamp 12V/24V White Front Marker Clear Lens

CCA-86BWM: Black Bezel 86x31x16mm

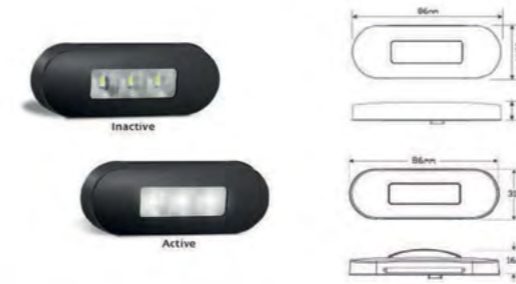

LED Autolamp 12V/24V Red Front Marker Clear Lens

CCA-86BRM: Black Bezel 86x31x16mm

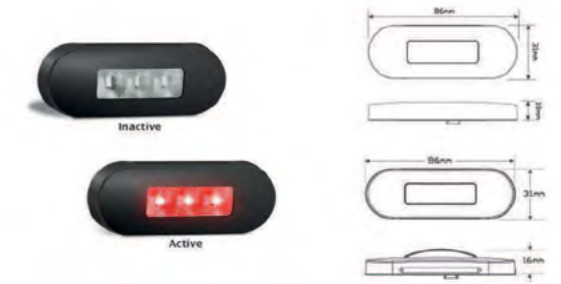

LED Autolamp 12V/24V R/Am Front Marker Clear Lens

CCA-86BARM: Black Bezel 86x31x16mm

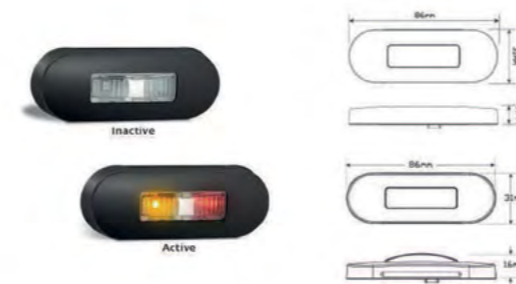

LED Autolamps White Front End Outline Marker Lamp

CCA-35WM: 58X35X21mm



LED Autolamps Amber Front End Outline Marker Lamp

CCA-35RM: 58X35X21mm



LED Autolamps Red Front End Outline Marker Lamp

CCA-380BAR12: 58X35X21mm

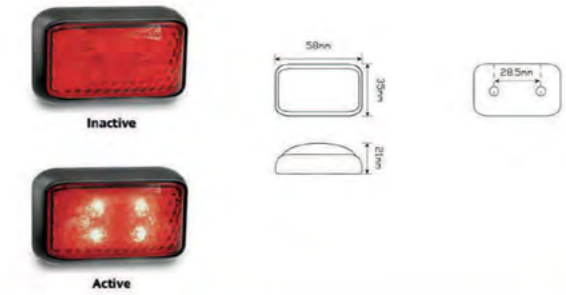

ED Autolamps Amb/Red Front End Outline Marker Lamp

CCA-35ARM: 58X35X21mm



LED Autolamp 12V/24V Amber Low Profile Side Marker

CCA-69AM: 120X64X22mm

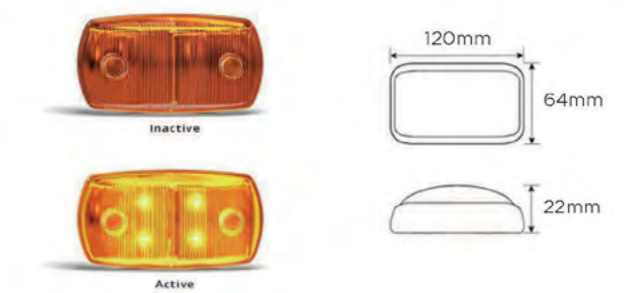

LED Autolamp 12V/24V White Low Profile Side Marker

CCA-69RM: 120X64X22mm

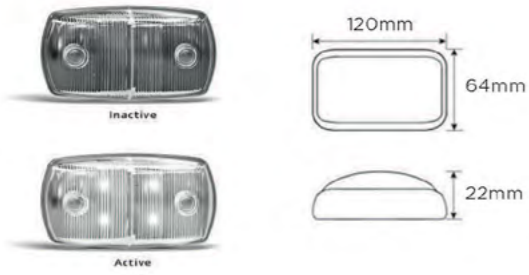

LED Autolamp 12V/24V Amb/Red Low Profile Side Marker

CCA-69RM: 120X64X22mm

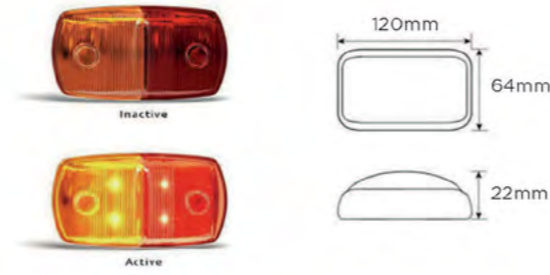

LED Autolamp 12V/24V White Front Outliner Marker

CCA-5025WMB: 3M Adhesive 50x25x21mm



LED Autolamp 12V/24V Red Front Outliner Marker

CCA-5025RMB: 3M Adhesive 50x25x21mm



LED Autolamp 12V/24V Licence Plate Light

CCA-35BLM: 76x41x27mm

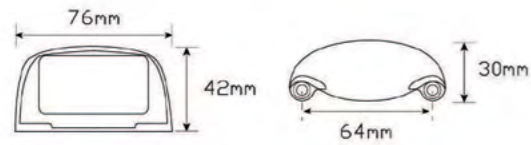

LED Autolamp 12V/24V Licence Plate Light

CCA-35BLMB: 76x41x27mm (Bulk Lot)

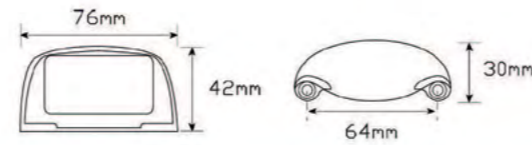

LED Autolamp 12V/24V Amber Front Outliner Marker

CCA-5025AMB: 3M Adhesive 50x25x21mm



LED Autolamp 12V/24V Red/Amber Front Outliner Marker

CCA-5025RAMB: 3M Adhesive 50x25x21mm



LED Autolamp 12V/24 2 x LED Number Plate Lights

CCA-30BLM 65X30X24mm

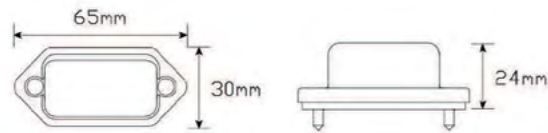

LED Autolamp 12V/24V Licence Plate Light

CCA-41BLM: 70x42x40mm

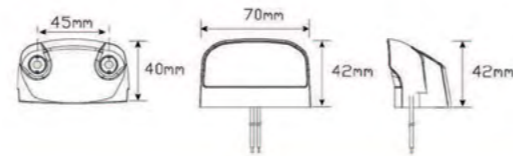

Built in Reflector / 3M Adhesive

CCA-EU38WMCBSB: Chrome Bezel



LED Autolamp 12V Slim Line Stop/Tail/Indicator Tail light

CCA-380BAR12: Black 428x97x22mm

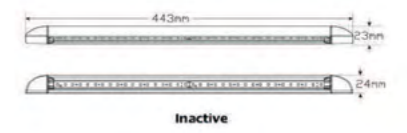

LED Autolamp 12/24V Stop/Tail/Sequential Indicator

CCA-355ARWM-2: Reverse/Reflector Taillight Chrome 355x85x34mm

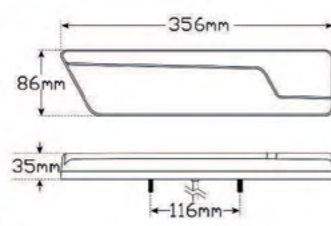

LED Autolamp 12/24V Stop/Tail/Sequential Indicator

CCA-520ARRMB: Reverse/Reflector Taillight 193x123x26mm

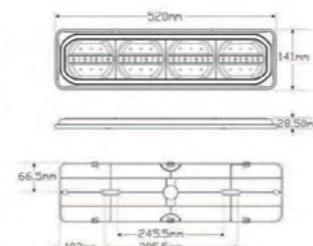

LED Autolamp 12/24V LED Number Plate Frame

CCA-LP1: 12/24V LED Number Plate Frame

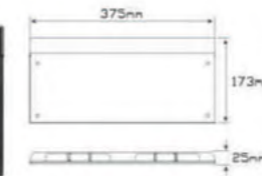

LED Autolamp 12/24V LED Number Plate Frame

CCA-LP1: 12/24V LED Number Plate Frame (6 lights)



LED Autolamp 12V Interior Reading Light with USB Port

CCA-RL60USB: Black 99x60x69mm



LED Autolamp 12V Interior Reading Light

CCA-RL60USB: USB Port Silver Aluminium

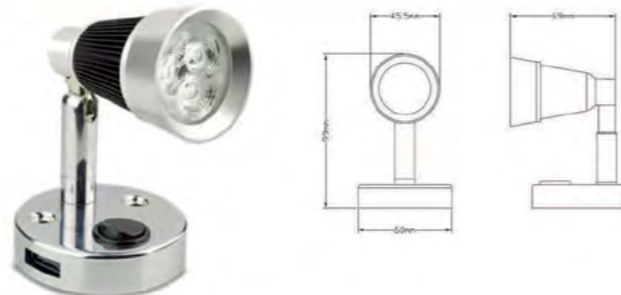

LED Autolamp Strip Interior LED Light with Touch Sensor

CCA-40260MCU: Black 260x40x11mm



LED Autolamp 12V Interior Strip Light with Touch Sensor Sw

CCA-40410MCU: Black 410x40x11mm



LED Autolamp 12V/24V Interior Strip Light

CCA-2460BMB-SW: Inc On / Off Switch 662X25X11mm



LED Autolamp 12V Awning Lamp

CCA-23260BLKB: 260x23X24mm Black

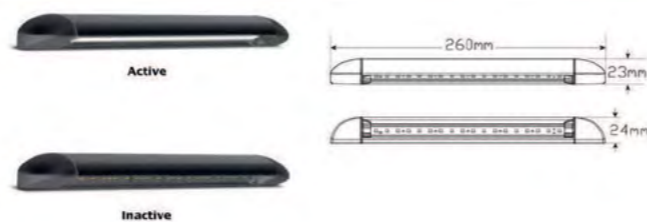

LED Autolamp 12V Interior low profile strip light

CCA-1061/12SWB: 300x25x10 White

LED Autolamp Large Round Interior/Exterior Lamp

CCA-13118WM-SW: Inc On / Off Switch 362x25x11mm



BM PRO POWER STATION POWERING YOUR ADVENTURES

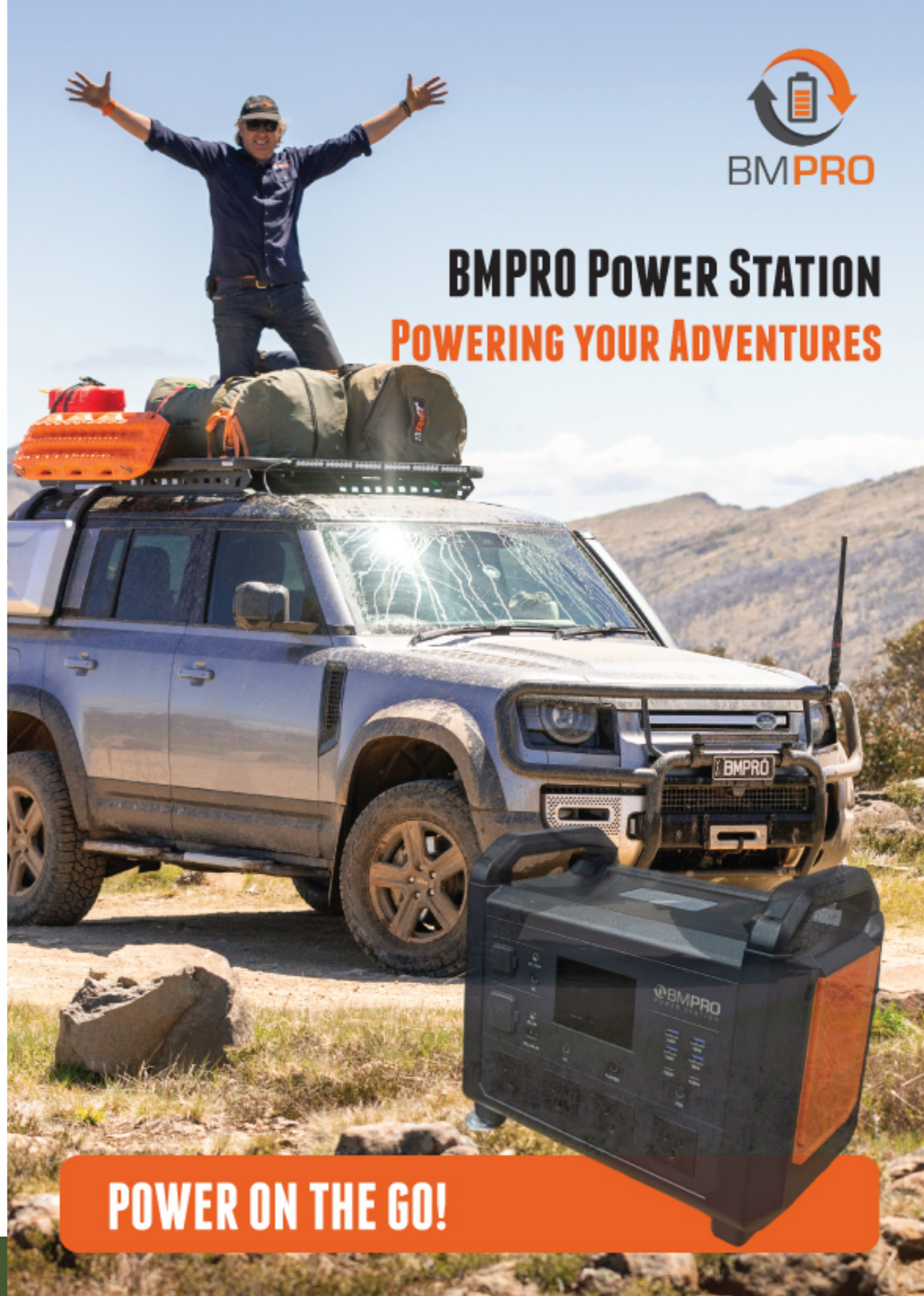

POWER ON THE GO!



BATTERYPLUS35-II-HA

BMPRO's BatteryPlus35-II-HA is a battery management system designed specifically for use in recreational vehicles. The BatteryPlus35-II operates from 110 to 240V AC mains power supply, towing vehicle auxiliary and solar panels to provide 35A of current to simultaneously power caravan loads and charge the caravan battery. The BatteryPlus35-II is available in multiple configurations and is compatible with the Odyssey system and Trek3 or Odyssey screen.



ASPOWER

BMPRO's ASPower is a battery management system designed for use in recreational vehicles, and is part of BMPRO's ASPero system. The ASPower operates from 240V AC mains power supply, towing vehicle auxiliary and solar panels to simultaneously power caravan loads and charge the caravan battery. The ASPower employs an intelligent charging algorithm, ensuring optimal battery health. The ASPower is used alongside the ASDisplay, which provides you with live and easy to understand information about your battery and water tanks.



PUREPRO2000W INVERTER

BMPRO's PurePro2000 is a pure sine wave inverter that can be used to power 220-240V appliances & devices, such as air conditioning, microwaves, hairdryers, power tools, laptops, coffee machines, & CPAP machines when on the road and camping off grid. With an LCD screen that shows vital information about your power usage & settings the PurePro 200 boasts:

- a remote switch, allowing you to operate it from any convenient location
- an automatic transfer switch that detects & switches between mains power & battery power
- integrated RCD protection for safety.



TREK3 SCREEN

BMPRO's Trek3 is a wall-mounted smart battery monitor designed specifically to operate with BMPRO's BatteryPlus35-II series of battery management systems. The Trek3 provides vital data at a glance, including caravan battery voltage, charging and discharging current, capacity indication and remaining time before the battery is completely discharged. The Trek3 also enables monitoring of water levels of up to four tanks and control of two water pumps, all from a sleek, wall-mounted display.



ODYSSEY SYSTEM

BMPRO's Odyssey is an in-built app-driven battery monitor and control console designed to operate with BMPRO's BatteryPlus35-II series of power management systems via the Odyssey-Link104. It provides information about the caravan's battery and power consumption, and allows you to monitor clean and dirty water tanks and caravan temperature, as well as control caravan features such as lights, slide-outs and water pumps from either the Odyssey tablet or wall switches. Odyssey is SmartConnect ready, allowing you to pair SmartConnect sensors so you can remotely control various aspects of your caravan.



MINIBOOST

BMPRO's MiniBoost is a compact DC-DC battery charger that allows you to charge a secondary battery using your towing vehicle's 12V system. If a smart alternator lowers the voltage, the MiniBoost uses a multistage charging algorithm to boost the voltage back up, ensuring a battery is fully charged at the end of a long drive. It is designed to charge all types of lead-acid batteries and when used with a lithium-compatible BMPRO BatteryPlus35, J35 or ASPERO battery management system, is able to charge LiFePO4 lithium batteries.



SMARTCONNECT SYSTEM

BMPRO's SmartConnect system is a range of Bluetooth sensors that can be paired with BMPRO smart systems to monitor critical functions of your caravan or RV. The SmartConnect range includes:

- SmartTemp for monitoring temperature.
- SmartSense for monitoring propane gas levels.
- SmartPressure for monitoring tyre pressure.

Once paired with your BMPRO smart system, information from the sensors can be viewed directly on the app.



ODYSSEY SWITCH

Our Odyssey RV Wall Switches are designed to give you easy access to all your essential controls, right at your fingertips. Whether you're in the cozy comfort of your bed, stepping into your RV after a long day of adventures, or relaxing in the lounge area, you can effortlessly control your lights and water pumps from multiple strategic locations within your RV.



DIPPER

BMPRO's Dipper is a digital water level indicator designed for use in both plastic and metal water tanks. The Dipper provides accurate readings of water levels in fresh and grey water tanks on RV's, camper trailers, and boats. The Dipper is easy to install and retrofitting is a DIY job thanks to the 5-pin connector located close to the ring terminal. It has been designed for use with BMPRO power management systems but is also compatible with a range of aftermarket tank level indicators. The Dipper is available in 2.5M, 5M, and 7.5M cable lengths.



POWERSTATION

The BMPRO Power Station brings you power on the go. Purpose built for use as a portable, versatile power unit, it utilises a number of ports and 1600W inverter. It can both charge and discharge a range of voltages in both AC and DC. The range also utilises the safe and efficient benefits of lithium LiFePO4 technology and is ideally suited to deep cycle longer run time applications.

For full range visit teambmp.com

Lion Batteries

Lion 100AH AGM Deep Cycle Battery

ILU-HZB12100S



Lion 100AH AGM Deep Cycle Battery 306x168x211mm 28.4Kg

Lion 120AH AGM Deep Cycle Battery

ILU-HZB12120S



Lion 120AH AGM Deep Cycle Battery 329x173x210mm 32.5Kg

Lion 120AH Lithium Deep Cycle Battery

ILU-LFP12100



Lion 120AH Lithium Deep Cycle Battery 307x169x208mm 13Kg

Lion 110AH Lithium Deep Cycle Battery

ILU-LFP12100SS



Lion 110AH Lithium Deep Cycle Battery Slim Steel Case 600x62x275mm 14.5Kg

Lion 150AH Lithium Deep Cycle Battery

ILU-LFP12120



Lion 150AH Lithium Deep Cycle Battery 329x172x214mm 14.5Kg

Lion 120AH Lithium Deep Cycle Battery Slim

ILU-LFP12120FA



Lion 120AH Lithium Deep Cycle Battery Slim 500x110x220mm 13Kg

Lion Batteries

Lion 200AH Lithium Deep Cycle Battery

ILU-LFP12150



Lion 200AH Lithium Deep Cycle Battery 483x170x240mm 18.5Kg

Lion 160AH Lithium Deep Cycle Battery Slim

ILU-LFP12150FA



Lion 160AH Lithium Deep Cycle Battery Slim 552x110x240mm 17.5Kg

Lion 300AH Lithium Deep Cycle Battery

ILU-LFP12200



Lion 300AH Lithium Deep Cycle Battery 520x269x220mm 33Kg

Finch 120AH Lithium Deep Cycle Battery

FIN-LFP12100S



Finch 120AH Lithium Deep Cycle Battery 307x169x208mm 13Kg

Finch 150AH Lithium Deep Cycle Battery

FIN-LFP12120S



Finch 150AH Lithium Deep Cycle Battery 329x172x214mm 14.5Kg

Finch 200AH Lithium Deep Cycle Battery

FIN-LFP12150S



Finch 200AH Lithium Deep Cycle Battery 483x170x240mm 18.5Kg



**View Products
Online**

☎ (03) 9305 1555

✉ info@caravanandcampingaus.com

🔍 caravanandcampingaus.com

👤 Mark Strangis
0418 134 766

👤 Roshan Chelvaratnam
0425 855 540

👤 Chad Helou
0458 048 999

👤 James Buckland
0491 086 044

All Things Caravanning



* Products & parts subject to change at any time.